



CHILDREN PLAYGROUND EQUIPMENT

CHILDREN AND SPORTS PLAYGROUNDS



OUTDOOR FITNESS



PARK FURNITURE



WORKOUT



SPORT EQUIPMENT



CONTENT

ABOUT COMPANY.....4
 SAFETY.....6
 POSSIBLE COLOR OPTIONS.....8

CHILDREN PLAYGROUNDS10
 Series «Little kids».....11
 Series«Spring».....17
 Series «City».....18
 Series «Bigcity».....20
 Kids sport elements.....25
 Series «Adrenalin».....26
 Rope complexes.....27
 Private use equipment.....28
 Slides/spring-riders.....29
 Balancers/carousels.....30
 Playsand equipment.....31
 Swings.....32
 Cars and trains.....33
 Thematic play complexes.....34
 Series«NEW».....40
 Series «Fairy forest».....42
 Inclusive equipment.....43
 Gymnatic complexes.....44

SPORT EQUIPMENT.....46

WORKOUT EQUIPMENT.....52

OUTDOOR FITNESS.....58
 Series SM.....59
 Series SMP.....62
 Series SE/SL.....65
 Weight resistance machines KF.....70

PARK FURNITURE.....72
 Children benches/fences.....73
 Complect series of park furniture.....74
 Park trash-bins.....76
 Bicycle parkings.....76
 Park benches.....77

DOGS TRAINING EQUIPMENT.....80

EQUIPMENT FOR STADIUMS AND
 PLAY SPORTS.....82

SURFACES FOR PLAYGROUNDS.....84

POLYURETHANE FIGURES.....85

01

02

03

04

05

06

07

ABOUT COMPANY



The main advantage of the Inter Atletika Group of Companies is its own production with a design office and modern equipment that allows performing the most complex orders and constantly expanding and improving the product range and quality.

In 2006, the enterprise received an international certificate ISO 9001: 2015 on the Quality Management System of LLC «Company Sporttehnika», which is a member of the «Inter Atletika». The company in 2010 certified the products in compliance with the EN1176 European safety standards for children's playgrounds and EN16630 - for outdoor exercise machines.

The company is a constant supplier of products to customers to over 40 countries of the world.



CHILDREN AND SPORTS PLAYGROUNDS

We provide all assortment of children, sports and urban equipment for developing territories near parks, hotels, recreational zones, kindergardens, schools, military bases and etc.

OUR PROJECTS:

- Installation of children and sports playgrounds (more that 100 000 playgrounds installed)
- Installation and equipping all kinds of sports playgrounds for play sports (football, volleyball, basketball, etc)

Our production facilities are located in Ukraine, Chernihiv city. Keeping investing in factory modernization and development, we are proud to say that Inter Atletika products meet the best quality standards.

WE CONSTANTLY MAKE SURE WE HAVE:

- Up-to-date automatic equipment;
- Quality control at each production stage
- Qualified personnel;
- Modern technologies in the production process.



SAFETY OF EQUIPMENT

Inter Atletika equipment is designed and produced according to European safety standards.

We offer equipment, which meets high quality and safety standards.

Our equipment conforms safety standard EN1176:2017 for children playground equipment and EN16630:2015 for outdoor fitness equipment. Certification and tests are provided by TUV Rheinland specialists.

We use these safety standards during all process of design and manufacturing of our equipment. We use only first class materials and there is also quality control on every step of production to achieve the high-quality equipment during the maintenance of the wood, metal, welding, painting, assemble, packaging and delivery.

Certified equipment is the guarantee of safety for every used on the playground.

Also, except the quality of equipment, it has to be proped installed on the playground to prevent any injuries. We provide all kinds of technical manuals and share all our experience with our partners to have safety installation of our playgrounds.

Safety playground has to meet many levels of quality: design according with safety standards, high quality materials, modern production, proper installation and safety surface.

Safety standard describes all requirements for equipment on every step of it's life cycle: design, production, quality control, regular inspections and etc.

A lot of attention is being focused on technical dimensions, parameters and gaps of equipment: distances between stairs, angle of the slide, height level of the bars, dimensions of the fences and barriers, presence of safety bars on platforms and etc. For example, you can use only soft rubber seats and chains on the swings to prevent any injuries during it's movement. Also, all equipment has to be installed on the playground with respect to safety zones - it means, no other equipment could be situated in the movement space of other items.

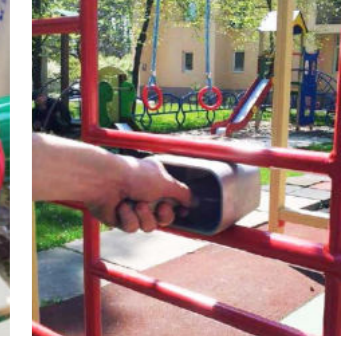
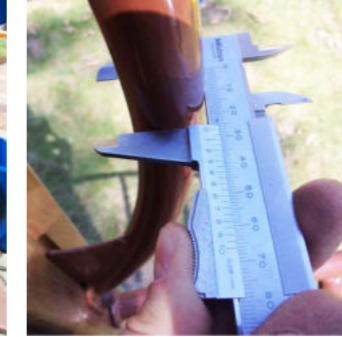
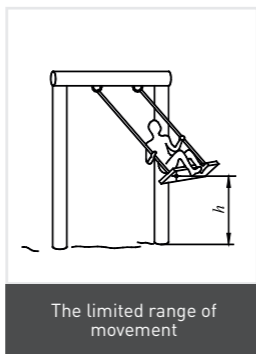
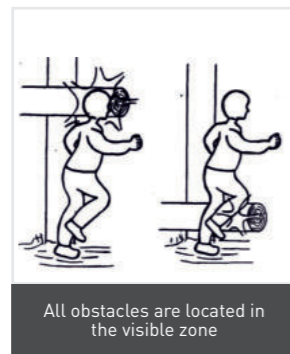
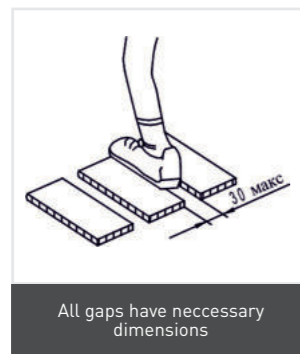

Safe, quality and certified sports equipment - is the guarantee of safety use, trainings and high results of the training process.

There a lot of situations, when sports training equipment doesn't meet the requirements of the users: it starts to break, to luft and other cases.

Inter Atletika company produces high-quality certified equipment, which is confirmed by EN16630:2015 safety certificate.

All samples are being tested by safety experts: there are being checked mathematical integrity calculations and all elements are being checked with loading tests.

Inter Atletika equipment is being checked on all steps of it's life cycle: during production, before shipment to customer and after installation.

We use only high quality materials, our factory facility has only first-class production equipment, and we use all our 25-years experience in design and construction of sports equipments.



COLOR OPTIONS

COLOR OPTIONS WITH HDPE PLASTICS

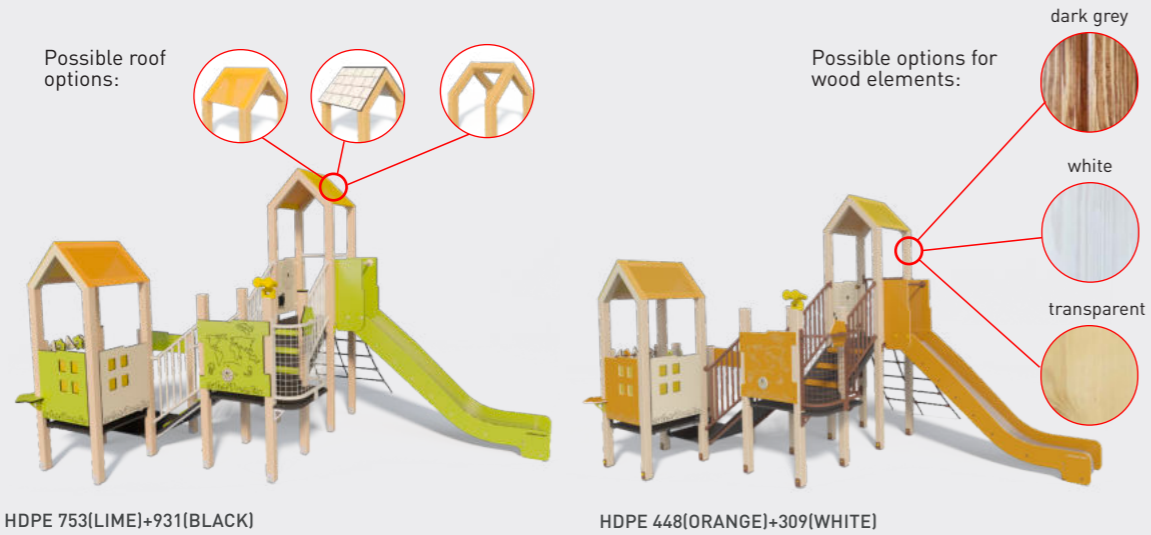

POSSIBLE COLOR OPTIONS FOR WORKOUT



OUTDOOR FITNESS EQUIPMENT

POSSIBLE COLOR OPTIONS

RAL 1001 sandy, texture		RAL 1018 yellow
RAL 2004 orange		RAL 3028 red
RAL 5015 blue		RAL 6018 green
RAL 7001 light gray		RAL 7003 olive, texture
RAL 7016 dark grey		RAL 7016 dark grey, texture
RAL 8002 brown		RAL 9001 creamy white
RAL 9003 white		RAL 9005 black, texture
МЕТАЛІК oxamite,		МЕТАЛІК oxamite, texture

POSSIBLE COLOR OPTIONS FOR OUTDOOR FITNESS

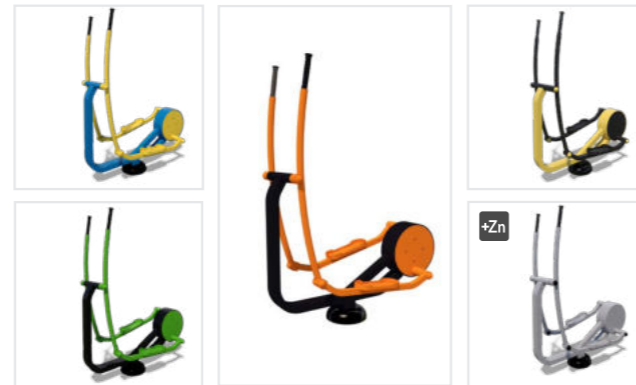

POSSIBLE COLOR OPTIONS FOR MULTIFITNESS



+Zn Metal parts can be covered with zink layer. It provides additional durability and anti-rust protection.

SAFETY SURFACES for children and sports playgrounds

Safety rubber is the obligatory part and the best surface to use on the any kind of playgrounds.

ADVANTAGES:

- long-time usage
- safety
- visual look
- suits for any kind of weather
- easy to maintain
- wide range of colours

COLOR OPTIONS

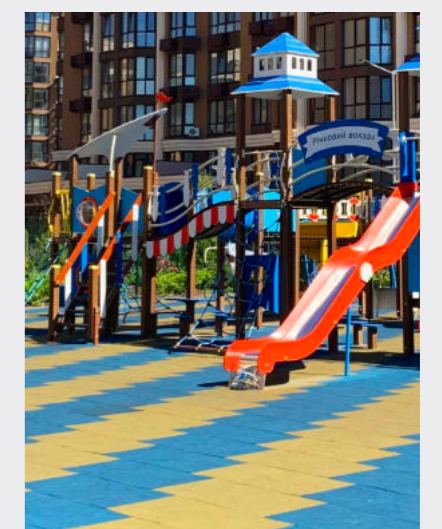
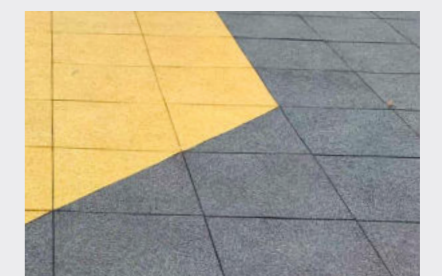



CHILDREN PLAYGROUNDS

SERIES «LITTLE KIDS»

LK101

length /mm/ 4955
width /mm/ 4085
height /mm/ 2899



LK102

length /mm/ 2953
width /mm/ 1580
height /mm/ 2899



LK103

length /mm/ 3326
width /mm/ 1237
height /mm/ 2899



LK104

length /mm/ 3794
width /mm/ 3000
height /mm/ 2899



LK105

length /mm/ 4424
width /mm/ 2415
height /mm/ 2899



LK106

length /mm/ 3100
width /mm/ 4007
height /mm/ 2899



CHILDREN PLAYGROUNDS

LK107

length /mm/ 4337
width /mm/ 2552
height /mm/ 2899



LK108

length /mm/ 2457
width /mm/ 3745
height /mm/ 2899



LK113

length /mm/ 3938
width /mm/ 3554
height /mm/ 2900



LK114

length /mm/ 4442
width /mm/ 3276
height /mm/ 2900



LK109

length /mm/ 3673
width /mm/ 3115
height /mm/ 2899



LK110

length /mm/ 5828
width /mm/ 3848
height /mm/ 2899



LK115

length /mm/ 2800
width /mm/ 4030
height /mm/ 2900

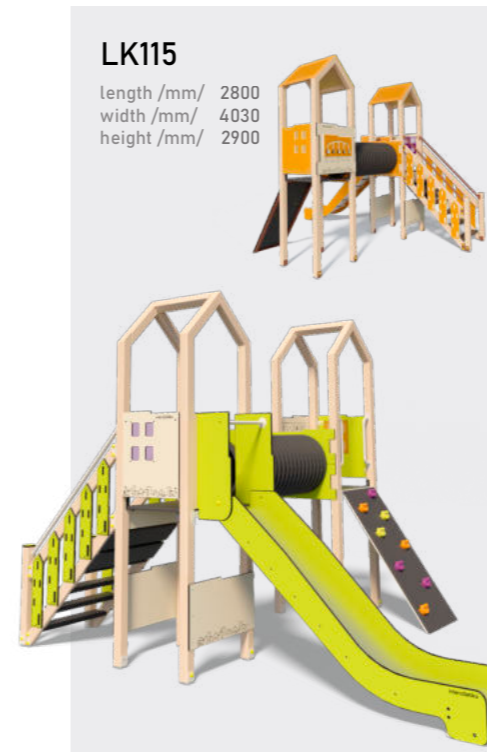

LK150.1

length /mm/ 4869
width /mm/ 2825
height /mm/ 1963



LK111

length /mm/ 4619
width /mm/ 2548
height /mm/ 2349



LK112

length /mm/ 4450
width /mm/ 2764
height /mm/ 2349



LK150.2

length /mm/ 6182
width /mm/ 4147
height /mm/ 2760



CHILDREN PLAYGROUNDS



LK150.4
 length /mm/ 7752
 width /mm/ 5078
 height /mm/ 2760



LK303
 length /mm/ 1540
 width /mm/ 2375
 height /mm/ 1900



LK151.1
 length /mm/ 3983
 width /mm/ 3098
 height /mm/ 2363



LK151.2
 length /mm/ 4955
 width /mm/ 4897
 height /mm/ 2563



LK304
 length /mm/ 1647
 width /mm/ 1664
 height /mm/ 1900



LK305
 length /mm/ 1485
 width /mm/ 1951
 height /mm/ 1900



LK301
 length /mm/ 963
 width /mm/ 1010
 height /mm/ 1900



LK302
 length /mm/ 1540
 width /mm/ 1572
 height /mm/ 1900



LK306
 length /mm/ 1485
 width /mm/ 1685
 height /mm/ 2064



LK307
 length /mm/ 2519
 width /mm/ 2764
 height /mm/ 1900



LK308

length /mm/ 2842
width /mm/ 2151
height /mm/ 1899



LK601

length /mm/ 1447
width /mm/ 767
height /mm/ 1122

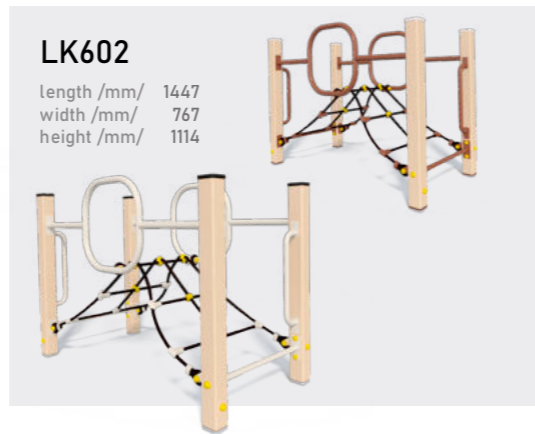

LK602

length /mm/ 1447
width /mm/ 767
height /mm/ 1114



LK603

length /mm/ 1447
width /mm/ 767
height /mm/ 864



LK604

length /mm/ 1447
width /mm/ 767
height /mm/ 1064

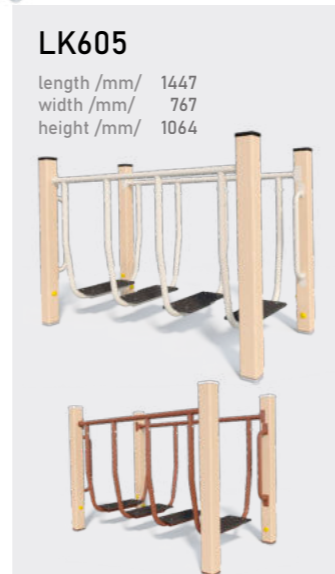

LK605

length /mm/ 1447
width /mm/ 767
height /mm/ 1064



LK606

length /mm/ 2089
width /mm/ 881
height /mm/ 865

SERIES «SPRING»

Made with using HPL plastics.

Pine-glued beam.

HPL plastic - durable and endurance material for children playgrounds, which doesn't burn and color-stable for a long period of time.



TL101

length /mm/ 3051
width /mm/ 2858
height /mm/ 2495



TL103

length /mm/ 3056
width /mm/ 4397
height /mm/ 2495



TL102

length /mm/ 3373
width /mm/ 4141
height /mm/ 2495



SERIES «CITY»

TE831
 length /mm/ 3049
 width /mm/ 2891
 height /mm/ 2371

possible roof options

TE832
 length /mm/ 3576
 width /mm/ 3833
 height /mm/ 3157

можливі варіанти даху

TE833
 length /mm/ 4564
 width /mm/ 4556
 height /mm/ 3172

possible roof options



TE834
 length /mm/ 4453
 width /mm/ 3113
 height /mm/ 2371

possible roof options

TE431
 length /mm/ 2703
 width /mm/ 460
 height /mm/ 2109

TE431A
 length /mm/ 2702
 width /mm/ 1000
 height /mm/ 2109



TE243
 length /mm/ 724
 width /mm/ 429
 height /mm/ 931

TE242
 length /mm/ 3010
 width /mm/ 500
 height /mm/ 789

TE247
 length /mm/ 785
 width /mm/ 429
 height /mm/ 1156

TE244
 length /mm/ 1227
 width /mm/ 1227
 height /mm/ 722

TE331
 length /mm/ 1600
 width /mm/ 1600
 height /mm/ 325

TE246
 length /mm/ 638
 width /mm/ 720
 height /mm/ 1700

TE245
 length /mm/ 827
 width /mm/ 827
 height /mm/ 721

TE331.1
 length /mm/ 873
 width /mm/ 769
 height /mm/ 507

CHILDREN PLAYGROUNDS

SERIES «BIG CITY»

TE930
length /mm/ 11490
width /mm/ 9765
height /mm/ 6023



TE933
length /mm/ 11263
width /mm/ 10123
height /mm/ 3923



TE931

length /mm/ 12143
width /mm/ 8453
height /mm/ 3470



TE932

length /mm/ 13145
width /mm/ 10124
height /mm/ 3920



TE934

length /mm/ 12723
width /mm/ 7274
height /mm/ 6013

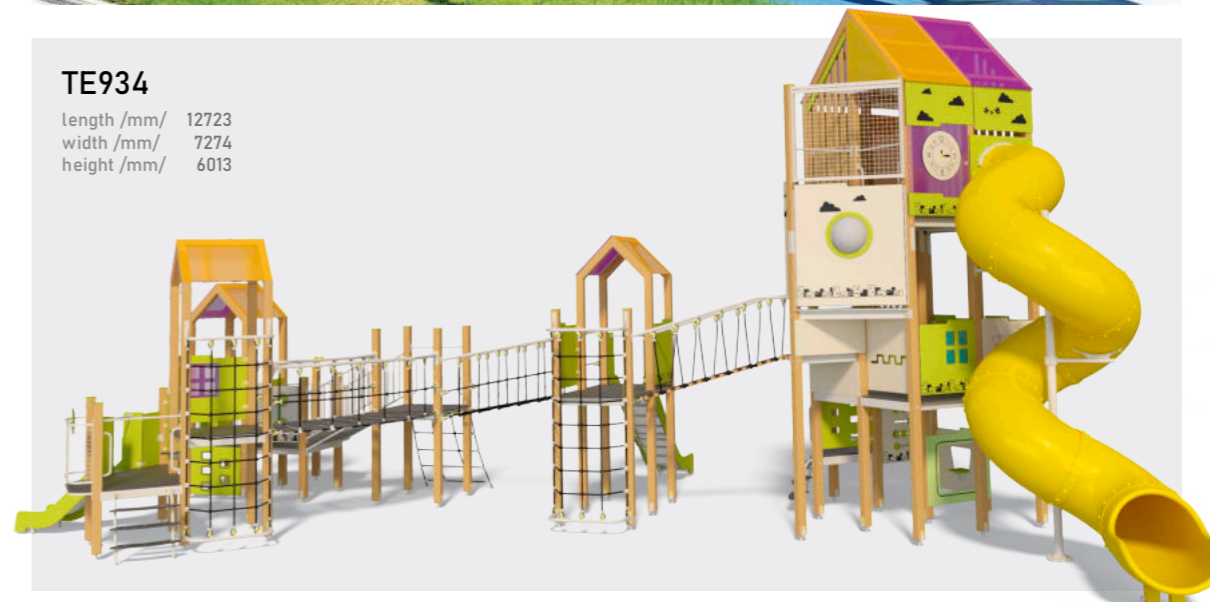



TE935
 length /mm/ 10176
 width /mm/ 11425
 height /mm/ 6023



TE938
 length /mm/ 8572
 width /mm/ 8070
 height /mm/ 3470



TE937
 length /mm/ 6023
 width /mm/ 8919
 height /mm/ 7647



TE939
 length /mm/ 5913
 width /mm/ 4733
 height /mm/ 6013



TE936
 length /mm/ 6190
 width /mm/ 5743
 height /mm/ 3470





TE940
length /mm/ 9904
width /mm/ 9746
height /mm/ 6011



TE941
length /mm/ 9835
width /mm/ 6104
height /mm/ 6018



TE942
length /mm/ 10516
width /mm/ 8442
height /mm/ 3917



TE943
length /mm/ 7903
width /mm/ 6821
height /mm/ 3461



TE944
length /mm/ 11021
width /mm/ 6964
height /mm/ 6013

KIDS SPORT ELEMENTS



Bicycle
SK101
length /mm/ 592
width /mm/ 418
height /mm/ 829
weight /kg/ 24,4

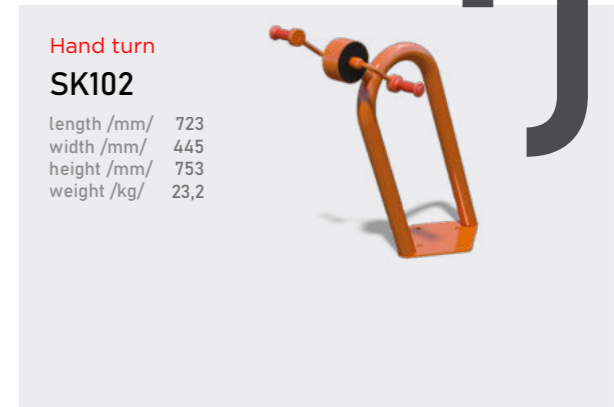

Hand turn
SK102
length /mm/ 723
width /mm/ 445
height /mm/ 753
weight /kg/ 23,2



Elliptical
SK103
length /mm/ 1438
width /mm/ 398
height /mm/ 951
weight /kg/ 49,9



Rider
SK104
length /mm/ 625
width /mm/ 440
height /mm/ 915
weight /kg/ 28,2



Spinner
SK105
length /mm/ 1430
width /mm/ 555
height /mm/ 907
weight /kg/ 38,5

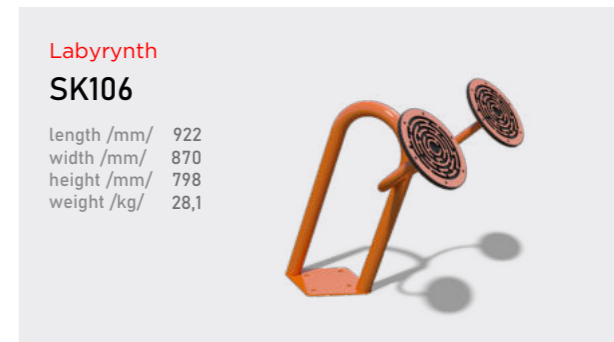

Labyrinth
SK106
length /mm/ 922
width /mm/ 870
height /mm/ 798
weight /kg/ 28,1



Excavator
T241
length /mm/ 1057
width /mm/ 305
height /mm/ 1160
weight /kg/ 22,6

Kids sport elements are designed by the sample of outdoor fitness equipment. Exercising here is good for early physical education and the strengthening of all body muscles. Kids are improving their coordination, balance, learn how to focus on the task.

Equipment is designed for exercising in the play form. Recommended for installation in kindergardens, parks, hotels, resorts and other recreational places.

SERIES «ADRENALIN»

TE223

length /mm/ 3605
width /mm/ 341
height /mm/ 2783
weight /kg/ 191.7



TE223.4

length /mm/ 3750
width /mm/ 3750
height /mm/ 2763
weight /kg/ 247.5



TE224

length /mm/ 3036
width /mm/ 428
height /mm/ 3170
weight /kg/ 169.7



TE225

length /mm/ 3295
width /mm/ 3295
height /mm/ 2962
weight /kg/ 202.1



TE226

length /mm/ 1837
width /mm/ 1837
height /mm/ 759
weight /kg/ 69.2

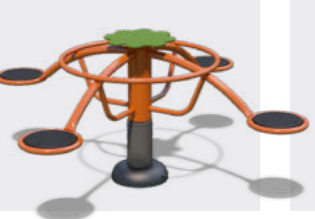

TE227

length /mm/ 1234
width /mm/ 1229
height /mm/ 1100
weight /kg/ 87.5



TE228

length /mm/ 2060
width /mm/ 1430
height /mm/ 2588
weight /kg/ 113.2

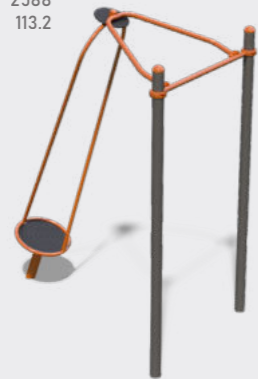

TE228.3

length /mm/ 3686
width /mm/ 4175
height /mm/ 2588
weight /kg/ 250.2

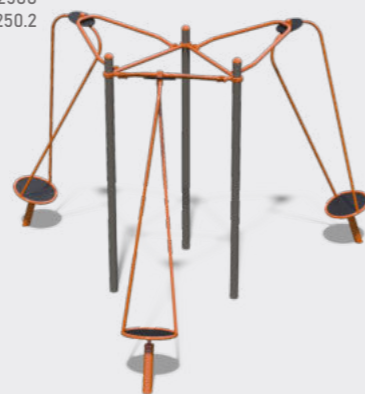

T416

length /mm/ 7218
width /mm/ 7218
height /mm/ 2138
weight /kg/ 413



ROPE COMPLEXES

SE770.3

length /mm/ 4412
width /mm/ 3824
height /mm/ 3001

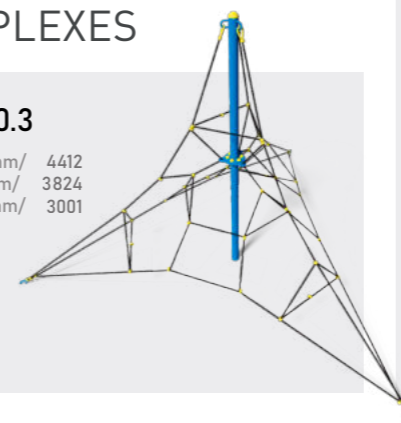

SE771.4

length /mm/ 6084
width /mm/ 6084
height /mm/ 4001

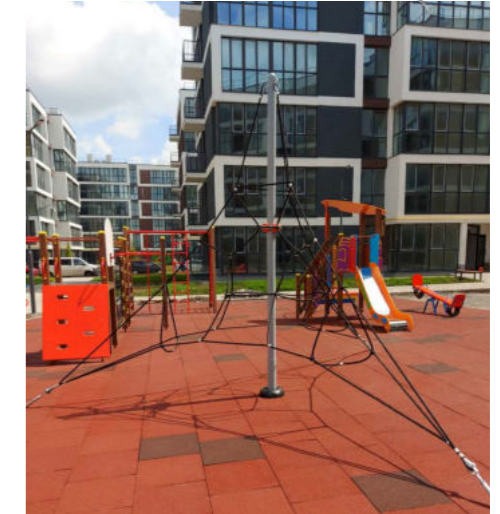
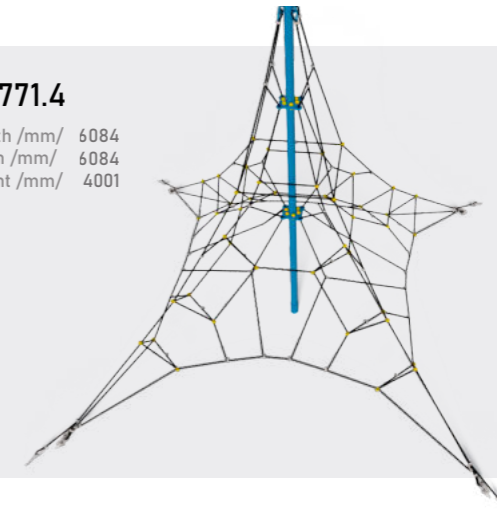

SE770.6

length /mm/ 6439
width /mm/ 4411
height /mm/ 3000

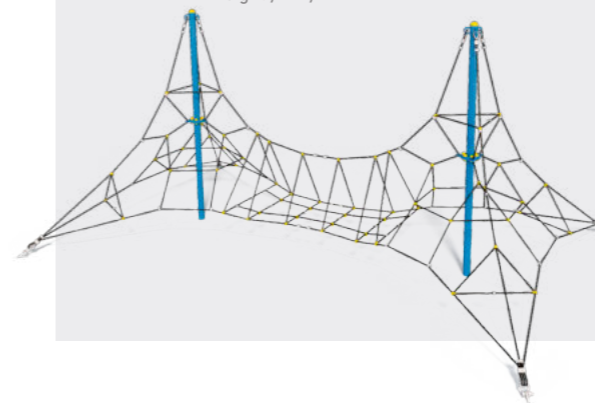

SE771.8

length /mm/ 11594
width /mm/ 6084
height /mm/ 4001

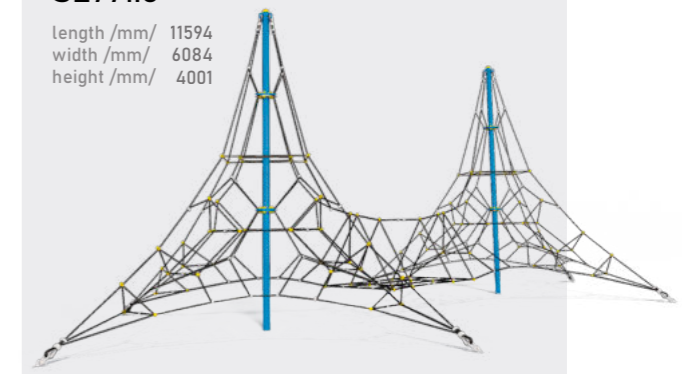

PRIVATE USE EQUIPMENT

These complexes are designed for use at the private home area.

These items do not require concrete during installation and they don't damage the surface.

P801B

length /mm/ 5700
width /mm/ 3280
height /mm/ 3100



P801.1B

length /mm/ 7100
width /mm/ 3280
height /mm/ 3100



P801.2B

length /mm/ 7215
width /mm/ 5297
height /mm/ 3100



SLIDES

TE101

length /mm/ 2232
width /mm/ 563
height /mm/ 1682



TE102

length /mm/ 3511
width /mm/ 563
height /mm/ 2280



TE107

length /mm/ 3022
width /mm/ 563
height /mm/ 2000



SPRING RIDERS

TE205

length /mm/ 1100
width /mm/ 720
height /mm/ 1210



TE208

length /mm/ 1200
width /mm/ 315
height /mm/ 1085

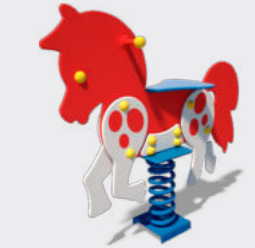

TE251PE

length /mm/ 763
width /mm/ 295
height /mm/ 961

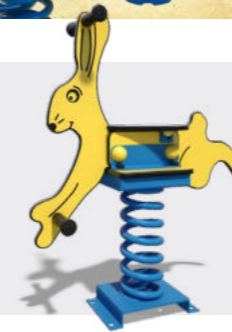

TE209

length /mm/ 1355
width /mm/ 532
height /mm/ 1342

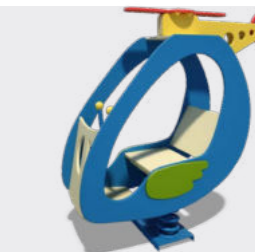

TE218

length /mm/ 691
width /mm/ 429
height /mm/ 821



T230

length /mm/ 793
width /mm/ 416
height /mm/ 693

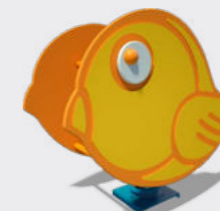

TE231

length /mm/ 720
width /mm/ 416
height /mm/ 689



TE232

length /mm/ 719
width /mm/ 416
height /mm/ 733



TE233

length /mm/ 787
width /mm/ 416
height /mm/ 761

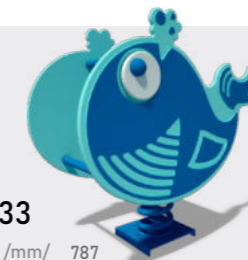

TE234

length /mm/ 727
width /mm/ 416
height /mm/ 789



BALANCERS

TE213

length /mm/ 3171
width /mm/ 333
height /mm/ 1229



TE201

length /mm/ 2171
width /mm/ 333
height /mm/ 1228



TE222

length /mm/ 2500
width /mm/ 556
height /mm/ 541



TE210

length /mm/ 1360
width /mm/ 263
height /mm/ 695

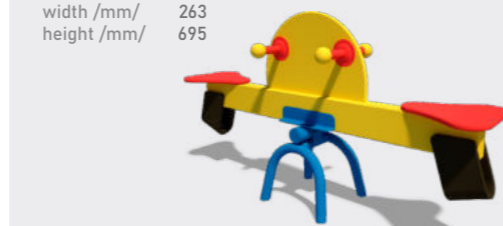

CAROUSELS

TE211

length /mm/ 1597
width /mm/ 1597
height /mm/ 712



TE212

length /mm/ 897
width /mm/ 897
height /mm/ 712



TE217

length /mm/ 1597
width /mm/ 1597
height /mm/ 791

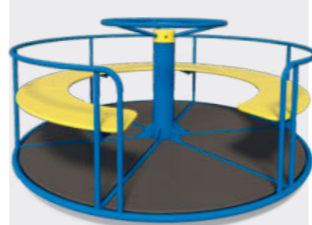

PLAYSAND EQUIPMENT

TE301/ TE302

length /mm/ 1450/1950
width /mm/ 1450/1950
height /mm/ 310/310



TE305

length /mm/ 1642
width /mm/ 1350
height /mm/ 1917



TE307

length /mm/ 3662
width /mm/ 1891
height /mm/ 2040

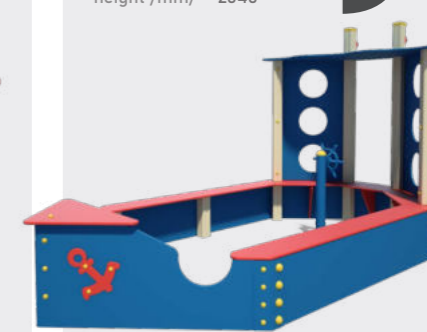

TE310

length /mm/ 1684
width /mm/ 1684
height /mm/ 1690



TE313

length /mm/ 1198
width /mm/ 1153
height /mm/ 520



T314

length /mm/ 1739
width /mm/ 1463/2902
height /mm/ 625/319



TE318

length /mm/ 2066
width /mm/ 948
height /mm/ 1392



TE319

length /mm/ 1750
width /mm/ 1642
height /mm/ 1940



SWINGS

TE402/ TE402M

length /mm/ 2255
width /mm/ 1362
height /mm/ 2086



TE404M/ TE404

length /mm/ 3655
width /mm/ 1362
height /mm/ 2086

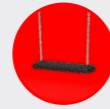
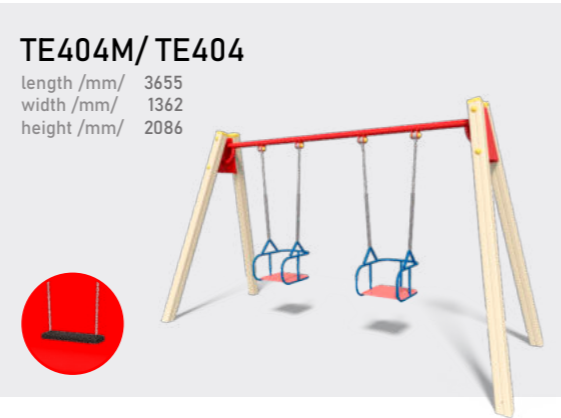

TE406M/ TE406

length /mm/ 1735
width /mm/ 985
height /mm/ 1992



TE407/ TE407M

length /mm/ 2800
width /mm/ 985
height /mm/ 1992

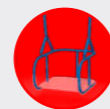

T408

length /mm/ 2370
width /mm/ 1560
height /mm/ 2270

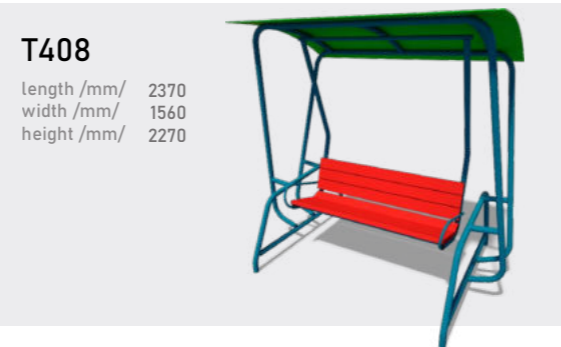

TE412

length /mm/ 3192
width /mm/ 1638
height /mm/ 2138



TE412RC

length /mm/ 2604
width /mm/ 1758
height /mm/ 2205



TE415

length /mm/ 2976
width /mm/ 1010
height /mm/ 2118



CARS AND TRAINS

TE508

length /mm/ 2961
width /mm/ 1275
height /mm/ 1415



TE509

length /mm/ 2412
width /mm/ 1278
height /mm/ 1749

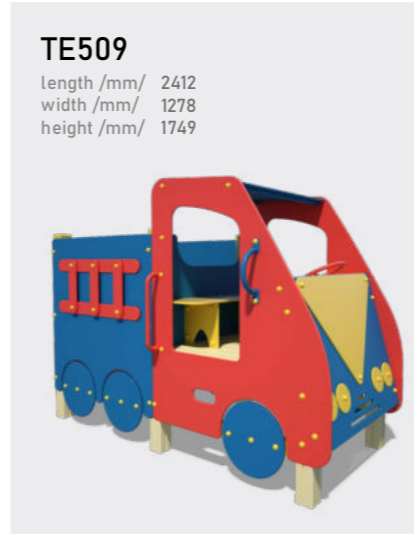

TE512

length /mm/ 3555
width /mm/ 2232
height /mm/ 2111



T507

length /mm/ 9213
width /mm/ 1225
height /mm/ 2115



TE510

length /mm/ 2141
width /mm/ 1202
height /mm/ 2115



T511

length /mm/ 3051
width /mm/ 1278
height /mm/ 1415



THEMATIC PLAY COMPLEXES

T809-RC

length /mm/ 8141
width /mm/ 6146
height /mm/ 3250

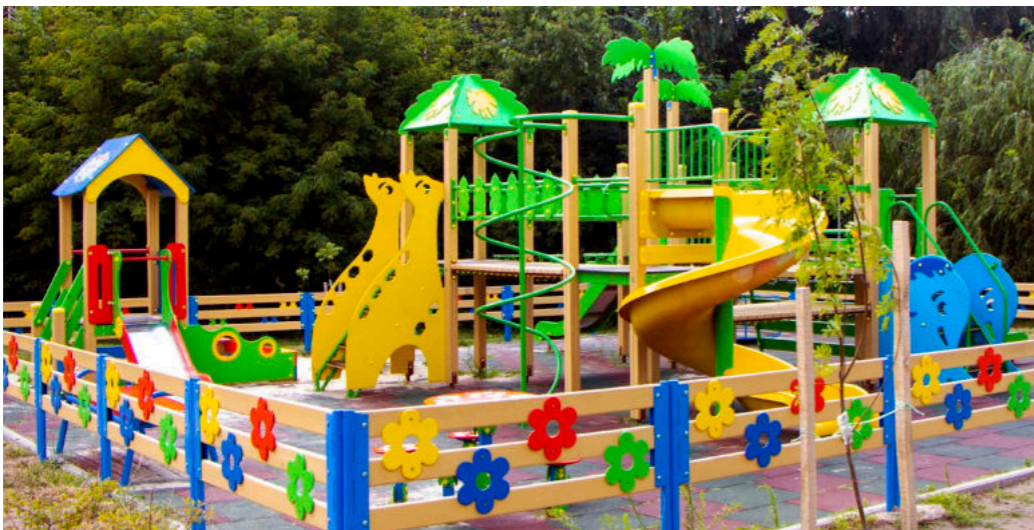

TE809.1

length /mm/ 6744
width /mm/ 4997
height /mm/ 3250



T907.2M

length /mm/ 9781
width /mm/ 3286
height /mm/ 3132



T903M

length /mm/ 8450
width /mm/ 6570
height /mm/ 4337



T904M

length /mm/ 11350
width /mm/ 7939
height /mm/ 4515



T907.1M

length /mm/ 7242
width /mm/ 5306
height /mm/ 3132



T907M

length /mm/ 8450
width /mm/ 8169
height /mm/ 3123



CHILDREN PLAYGROUNDS



T921
 length /mm/ 14096
 width /mm/ 12719
 height /mm/ 4491



T922
 length /mm/ 13067
 width /mm/ 12066
 height /mm/ 5369



T922.1
 length /mm/ 11887
 width /mm/ 7368
 height /mm/ 5368

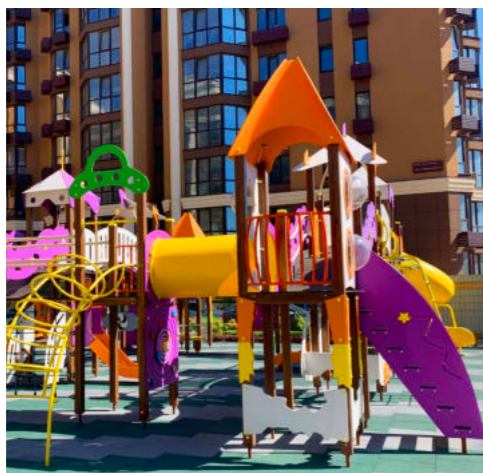

T921.1
 length /mm/ 10780
 width /mm/ 8992
 height /mm/ 4470

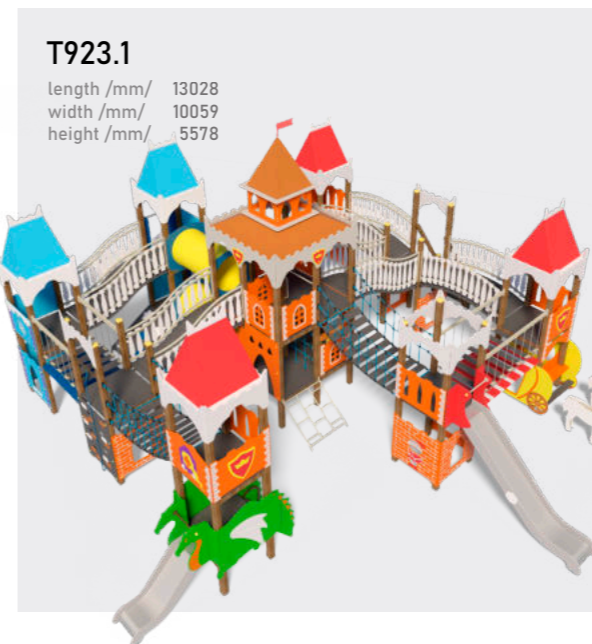

T923.1
 length /mm/ 13028
 width /mm/ 10059
 height /mm/ 5578



T918-VS-S715M
 length /mm/ 14733
 width /mm/ 9406
 height /mm/ 6284



T923
 length /mm/ 13028
 width /mm/ 10059
 height /mm/ 6000



CHILDREN PLAYGROUNDS

T915
length /mm/ 14043
width /mm/ 7189
height /mm/ 6443

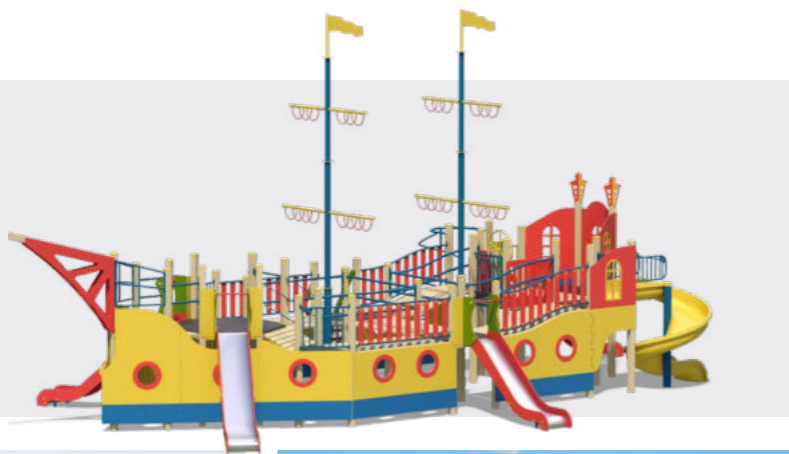

T917
length /mm/ 11925
width /mm/ 11130
height /mm/ 5857



T918
length /mm/ 9938
width /mm/ 7050
height /mm/ 6284



TE919
length /mm/ 6654
width /mm/ 4040
height /mm/ 2346



TE9130Ж3
length /mm/ 5366
width /mm/ 5050
height /mm/ 3538



T920
length /mm/ 14117
width /mm/ 12798
height /mm/ 4834

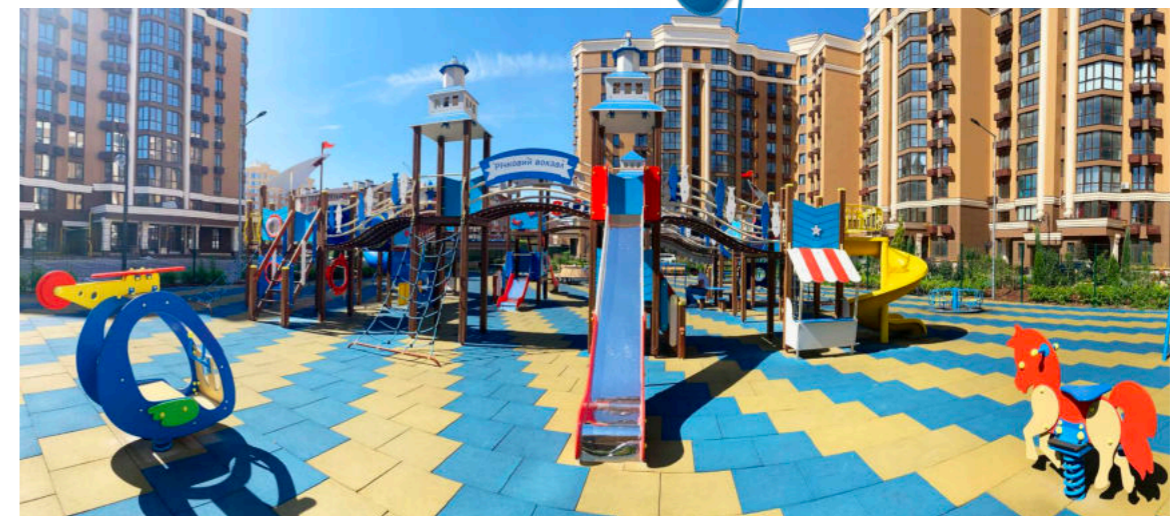
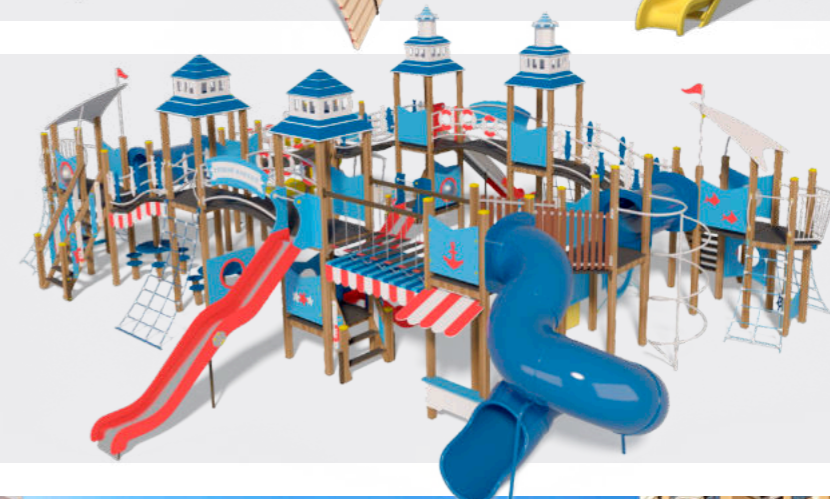

T920.1
length /mm/ 10799
width /mm/ 10287
height /mm/ 4836

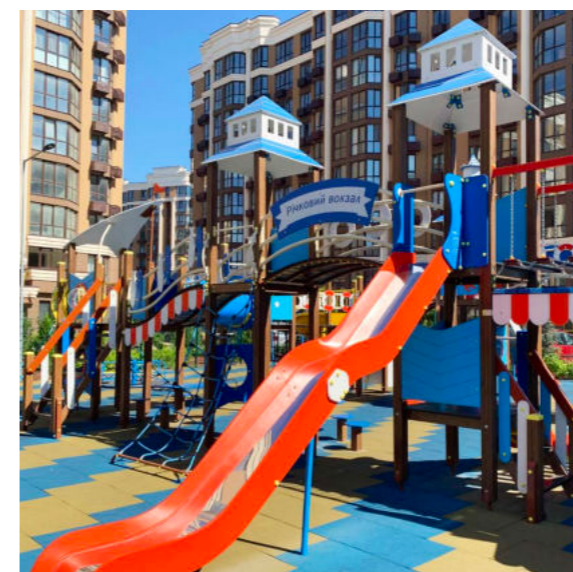

SERIES «NEW»

T801NEW

length /mm/ 3296
width /mm/ 2680
height /mm/ 2903



T802NEW

length /mm/ 5401
width /mm/ 3781
height /mm/ 2903



T803NEW

length /mm/ 6621
width /mm/ 4645
height /mm/ 2902



T901NEW

length /mm/ 5550
width /mm/ 3772
height /mm/ 3357



T902NEW

length /mm/ 8450
width /mm/ 4378
height /mm/ 3357



T903NEW

length /mm/ 8450
width /mm/ 6862
height /mm/ 3357



T904NEW

length /mm/ 11350
width /mm/ 7940
height /mm/ 3357



T911NEW

length /mm/ 11768
width /mm/ 7790
height /mm/ 3357



T912NEW

length /mm/ 11424
width /mm/ 11099
height /mm/ 3357



T912.1NEW

length /mm/ 12390
width /mm/ 11206
height /mm/ 5854



SERIES «FAIRY FOREST»

TE701

length /mm/ 3073
width /mm/ 3060
height /mm/ 3118



TE703

length /mm/ 3310
width /mm/ 1544
height /mm/ 2602



TE706

length /mm/ 10710
width /mm/ 6864
height /mm/ 3118



TE708

length /mm/ 10710
width /mm/ 8379
height /mm/ 3118



TE709

length /mm/ 12113
width /mm/ 9515
height /mm/ 3118



TE702.1

length /mm/ 5334
width /mm/ 4184
height /mm/ 3118



TE704

length /mm/ 7345
width /mm/ 5333
height /mm/ 3118



TE705.1

length /mm/ 8029
width /mm/ 6748
height /mm/ 3118



TE707

length /mm/ 10711
width /mm/ 6754
height /mm/ 3118



INCLUSIVE EQUIPMENT

TE835

length /mm/ 9556
width /mm/ 7827
height /mm/ 2373



T601

length /mm/ 13685
width /mm/ 4866
height /mm/ 1647



T604

length /mm/ 1499
width /mm/ 906
height /mm/ 945



T605.2

length /mm/ 1880
width /mm/ 1880
height /mm/ 682



GYMNASTIC COMPLEXES

S712

length /mm/ 5170
width /mm/ 1519
height /mm/ 3143

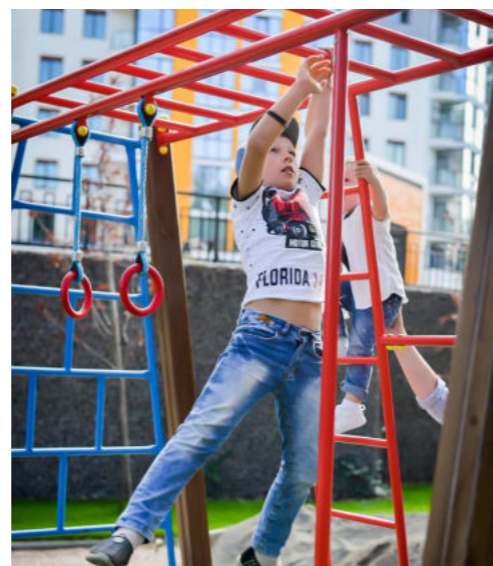

SE716

length /mm/ 2588
width /mm/ 1640
height /mm/ 2544



S723

length /mm/ 7045
width /mm/ 3417
height /mm/ 3293



S713

length /mm/ 6548
width /mm/ 2525
height /mm/ 2596



SE714

length /mm/ 3551
width /mm/ 3693
height /mm/ 2596



S715

length /mm/ 8626
width /mm/ 7605
height /mm/ 2595



S715.1M

length /mm/ 8567
width /mm/ 5834
height /mm/ 2109



S715.3M

length /mm/ 6605
width /mm/ 5563
height /mm/ 2595

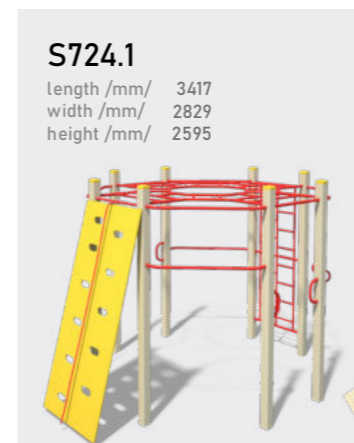

S724.1

length /mm/ 3417
width /mm/ 2829
height /mm/ 2595



S725

length /mm/ 6543
width /mm/ 2442
height /mm/ 2595

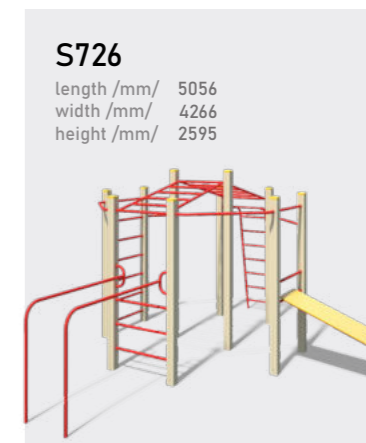

S726

length /mm/ 5056
width /mm/ 4266
height /mm/ 2595

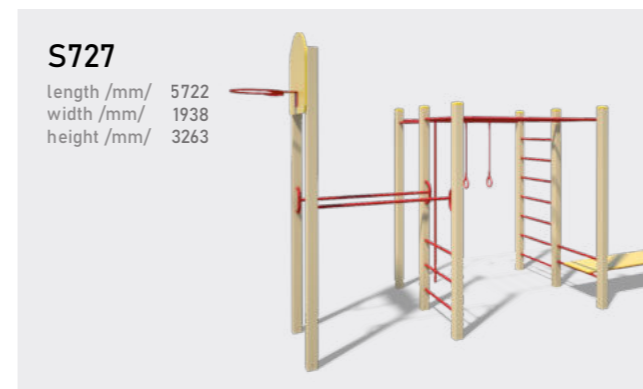

S727

length /mm/ 5722
width /mm/ 1938
height /mm/ 3263



SE760

length /mm/ 4415
width /mm/ 3076
height /mm/ 2318

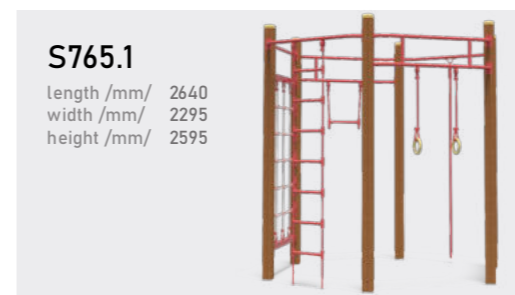

S765.1

length /mm/ 2640
width /mm/ 2295
height /mm/ 2595



S801

length /mm/ 5943
width /mm/ 4149
height /mm/ 3576

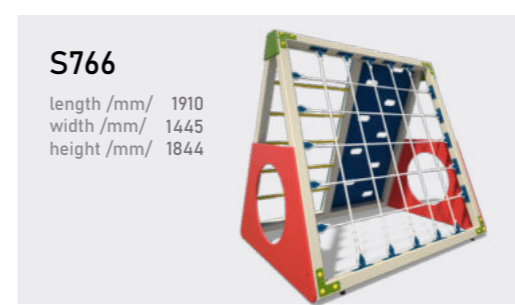









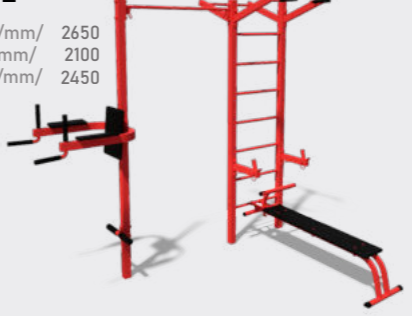





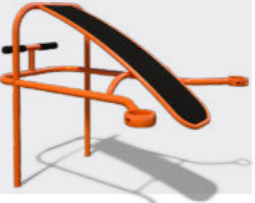
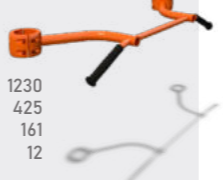

S766

length /mm/ 1910
width /mm/ 1445
height /mm/ 1844



FITNESS EQUIPMENT

<p>YT101</p> <p>length /mm/ 2070 width /mm/ 1700 height /mm/ 2430</p> 	<p>YT102</p> <p>length /mm/ 2650 width /mm/ 2100 height /mm/ 2450</p> 	<p>YT102.5 Swing seat</p> 
<p>YT102.4 Hang for punch bag</p> 	<p>YT102.9 Hyperextension</p> 	<p>YT102.10 Bar</p> 
<p>MF1.1</p> <p>length /mm/ 648 width /mm/ 130 height /mm/ 307 weight /kg/ 7</p> 	<p>MF1.2</p> <p>length /mm/ 1190 width /mm/ 1110 height /mm/ 1590 weight /kg/ 29</p> 	
<p>MF1.3</p> <p>length /mm/ 859 width /mm/ 859 height /mm/ 934 weight /kg/ 37</p> 	<p>MF1.4</p> <p>length /mm/ 714 width /mm/ 995 height /mm/ 2214 weight /kg/ 38</p> 	<p>MF1.5</p> <p>length /mm/ 714 width /mm/ 1199 height /mm/ 2000 weight /kg/ 28</p> 
<p>MF1.6</p> <p>length /mm/ 1230 width /mm/ 1356 height /mm/ 1139 weight /kg/ 36</p> 	<p>MF1.7</p> <p>length /mm/ 1230 width /mm/ 425 height /mm/ 161 weight /kg/ 12</p> 	<p>MF1.9</p> <p>length /mm/ 1230 width /mm/ 1364 height /mm/ 1225 weight /kg/ 29</p> 
<p>MF1.8</p> <p>length /mm/ 1230 width /mm/ 417 height /mm/ 144 weight /kg/ 17</p> 	<p>MF1.10</p> <p>length /mm/ 1230 width /mm/ 173 height /mm/ 45 weight /kg/ 7</p> 	<p>MF1.11</p> <p>length /mm/ 1230 width /mm/ 283 height /mm/ 2466 weight /kg/ 34</p> 
<p>MF1.12</p> <p>length /mm/ 530 width /mm/ 1720 height /mm/ 615 weight /kg/ 29</p> 	<p>MF1.13</p> <p>length /mm/ 1230 width /mm/ 718 height /mm/ 945 weight /kg/ 19</p> 	

FITNESS EQUIPMENT

MF2.1
 length /mm/ 648
 width /mm/ 130
 height /mm/ 2659
 weight /kg/ 35

MF2.2
 length /mm/ 1060
 width /mm/ 1190
 height /mm/ 1227
 weight /kg/ 45

MF2.3
 length /mm/ 859
 width /mm/ 859
 height /mm/ 727
 weight /kg/ 78

MF2.4
 length /mm/ 714
 width /mm/ 995
 height /mm/ 1712
 weight /kg/ 57

MF2.5
 length /mm/ 714
 width /mm/ 1199
 height /mm/ 1657
 weight /kg/ 47

MF2.6
 length /mm/ 1230
 width /mm/ 1356
 height /mm/ 639
 weight /kg/ 52

MF2.7
 length /mm/ 1230
 width /mm/ 425
 height /mm/ 2705
 weight /kg/ 68

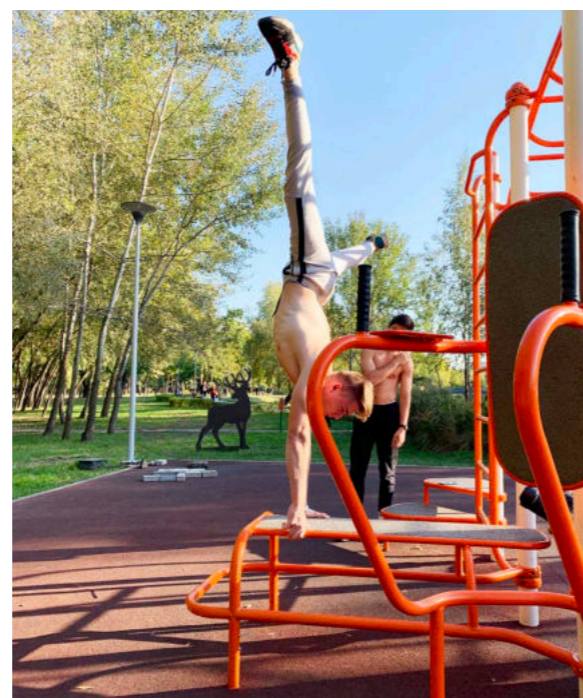

MF2.8
 length /mm/ 1230
 width /mm/ 416
 height /mm/ 2705
 weight /kg/ 74

MF2.9
 length /mm/ 1230
 width /mm/ 1367
 height /mm/ 725
 weight /kg/ 46

MF3.1
 length /mm/ 1200
 width /mm/ 189
 height /mm/ 2526
 weight /kg/ 72

MF3.2
 length /mm/ 1230
 width /mm/ 499
 height /mm/ 2526
 weight /kg/ 84

MF3.3
 length /mm/ 1230
 width /mm/ 490
 height /mm/ 2450
 weight /kg/ 89

MF3.4
 length /mm/ 3168
 width /mm/ 714
 height /mm/ 2526
 weight /kg/ 150

MF3.5
 length /mm/ 2477
 width /mm/ 1025
 height /mm/ 2440
 weight /kg/ 128

MF3.6
 length /mm/ 3259
 width /mm/ 2549
 height /mm/ 2526
 weight /kg/ 198

MF4.1
 length /mm/ 1316
 width /mm/ 1670
 height /mm/ 2705
 weight /kg/ 178

MF4.2
 length /mm/ 1820
 width /mm/ 1100
 height /mm/ 2705
 weight /kg/ 189

MF4.3
 length /mm/ 3211
 width /mm/ 2328
 height /mm/ 2705
 weight /kg/ 253

MF4.4
 length /mm/ 3153
 width /mm/ 3321
 height /mm/ 2705
 weight /kg/ 310



MF4.5

length /mm/ 3321
width /mm/ 3153
height /mm/ 2761
weight /kg/ 280

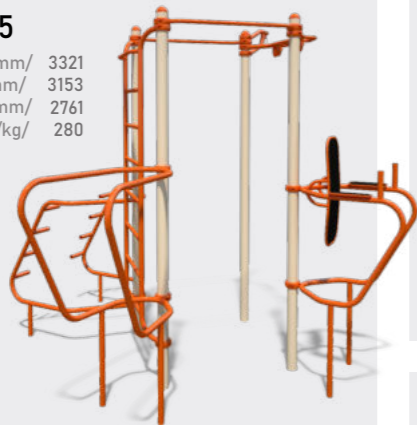

MF5.1

length /mm/ 2811
width /mm/ 1100
height /mm/ 2705
weight /kg/ 218



MF5.2

length /mm/ 3694
width /mm/ 2712
height /mm/ 2705
weight /kg/ 335



MF5.3

length /mm/ 4414
width /mm/ 3204
height /mm/ 2705
weight /kg/ 413



MF5.4

length /mm/ 4421
width /mm/ 3890
height /mm/ 2705
weight /kg/ 467

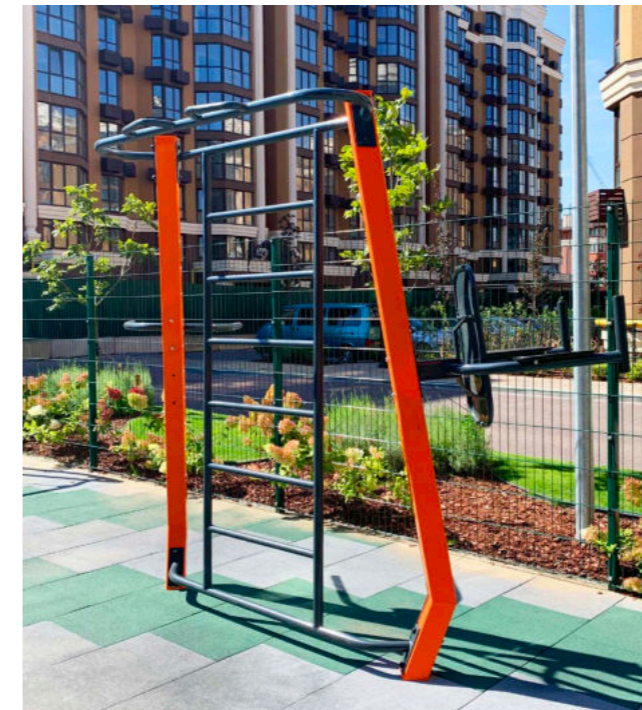

SM800

length /mm/ 3058
width /mm/ 1453
height /mm/ 2425
weight /kg/ 152



SM801

length /mm/ 4590
width /mm/ 3664
height /mm/ 2425
weight /kg/ 312



SM802

length /mm/ 5812
width /mm/ 4927
height /mm/ 2425
weight /kg/ 516



SM803

length /mm/ 5819
width /mm/ 4775
height /mm/ 3484
weight /kg/ 594





WORKOUT EQUIPMENT

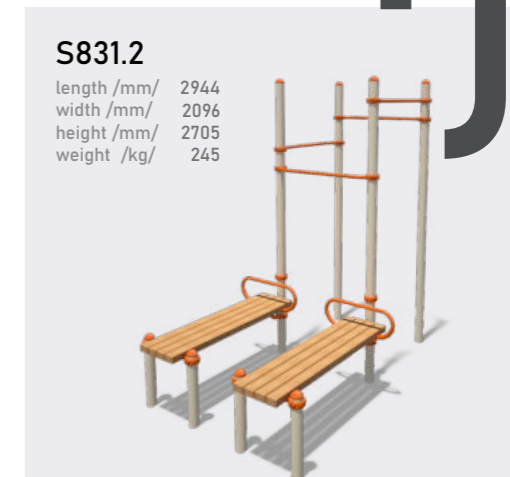

WORKOUT EQUIPMENT

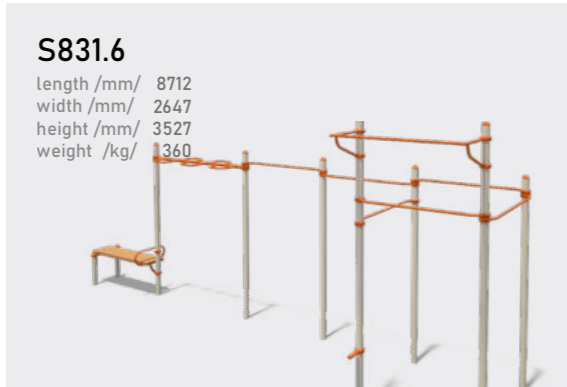

S831.6
length /mm/ 8712
width /mm/ 2647
height /mm/ 3527
weight /kg/ 1360



S831.8
length /mm/ 2192
width /mm/ 2808
height /mm/ 2705
weight /kg/ 238



S831.10
length /mm/ 5116
width /mm/ 1661
height /mm/ 2705
weight /kg/ 337



S831.11
length /mm/ 9971
width /mm/ 1526
height /mm/ 2705
weight /kg/ 474



S831.7
length /mm/ 1442
width /mm/ 2552
height /mm/ 2705
weight /kg/ 179



S831.9
length /mm/ 5181
width /mm/ 5580
height /mm/ 4127
weight /kg/ 622

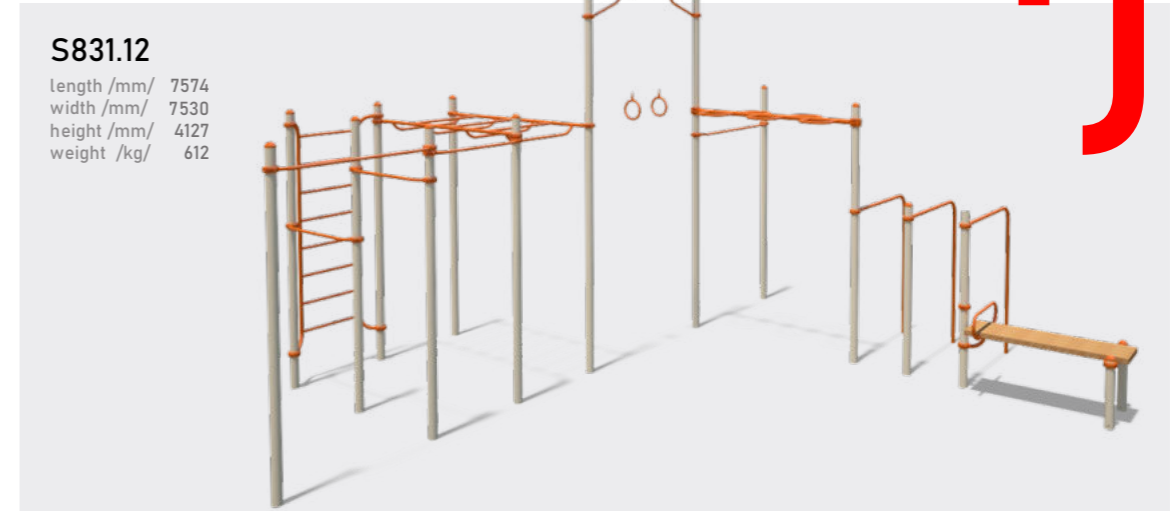

S831.12
length /mm/ 7574
width /mm/ 7530
height /mm/ 4127
weight /kg/ 612



S831.13
length /mm/ 13530
width /mm/ 7607
height /mm/ 4127
weight /kg/ 1438

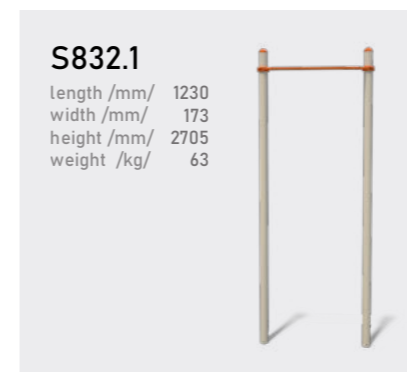

S832.1
length /mm/ 1230
width /mm/ 173
height /mm/ 2705
weight /kg/ 63

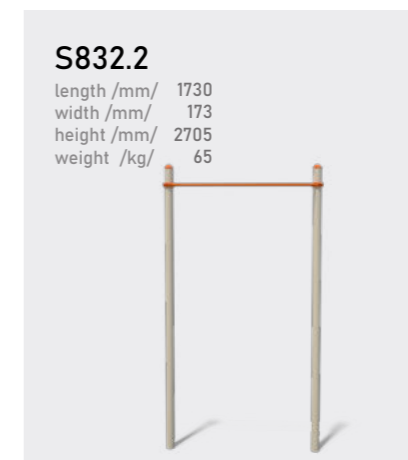

S832.2
length /mm/ 1730
width /mm/ 173
height /mm/ 2705
weight /kg/ 65



S832.3
length /mm/ 1230
width /mm/ 173
height /mm/ 1027
weight /kg/ 35



S832.4
length /mm/ 1316
width /mm/ 1316
height /mm/ 2705
weight /kg/ 137

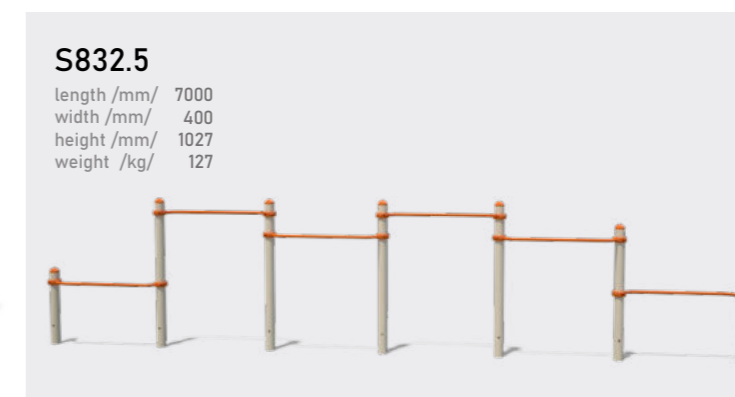

S832.5
length /mm/ 7000
width /mm/ 400
height /mm/ 1027
weight /kg/ 127

WORKOUT EQUIPMENT

S833.1
 length /mm/ 2330
 width /mm/ 686
 height /mm/ 2705
 weight /kg/ 82

S833.2
 length /mm/ 2330
 width /mm/ 1228
 height /mm/ 2705
 weight /kg/ 147

S833.3
 length /mm/ 4530
 width /mm/ 1228
 height /mm/ 2705
 weight /kg/ 238



S834.2
 length /mm/ 1630
 width /mm/ 996
 height /mm/ 1657
 weight /kg/ 95

S834.3
 length /mm/ 1630
 width /mm/ 996
 height /mm/ 327
 weight /kg/ 50

S834.4
 length /mm/ 1630
 width /mm/ 996
 height /mm/ 727
 weight /kg/ 77

S834.1
 length /mm/ 3130
 width /mm/ 873
 height /mm/ 1667
 weight /kg/ 150

S834.5
 length /mm/ 1414
 width /mm/ 1409
 height /mm/ 1657
 weight /kg/ 93

S834.6
 length /mm/ 1414
 width /mm/ 2231
 height /mm/ 1657
 weight /kg/ 95

S834.7
 length /mm/ 2330
 width /mm/ 996
 height /mm/ 699
 weight /kg/ 64

S835.1
 length /mm/ 1737
 width /mm/ 747
 height /mm/ 591
 weight /kg/ 61

S835.2
 length /mm/ 1668
 width /mm/ 747
 height /mm/ 1056
 weight /kg/ 63

S835.3
 length /mm/ 1800
 width /mm/ 650
 height /mm/ 627
 weight /kg/ 68

S835.4
 length /mm/ 1600
 width /mm/ 680
 height /mm/ 727
 weight /kg/ 79

S836.1
 length /mm/ 3698
 width /mm/ 4075
 height /mm/ 808
 weight /kg/ 167

S836.2
 length /mm/ 3430
 width /mm/ 326
 height /mm/ 2705
 weight /kg/ 161

S839.1
 length /mm/ 1230
 width /mm/ 283
 height /mm/ 2705
 weight /kg/ 91

S839.2
 length /mm/ 309
 width /mm/ 130
 height /mm/ 2705
 weight /kg/ 39

S839.3
 length /mm/ 2130
 width /mm/ 242
 height /mm/ 4127
 weight /kg/ 110





FITNESS MACHINES

SERIES «SM»



SM103

length /mm/ 1747
 width /mm/ 500
 height /mm/ 1508
 weight /kg/ 63



SM104

length /mm/ 1055
 width /mm/ 797
 height /mm/ 1426
 weight /kg/ 60,3

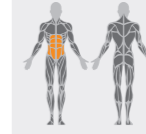

SM101

length /mm/ 1569
 width /mm/ 875
 height /mm/ 1918
 weight /kg/ 102



SM104-114

length /mm/ 1443
 width /mm/ 797
 height /mm/ 1426
 weight /kg/ 75,2

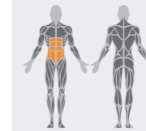

SM101-102

length /mm/ 1563
 width /mm/ 930
 height /mm/ 1918
 weight /kg/ 96



SM105

length /mm/ 1742
 width /mm/ 684
 height /mm/ 1728
 weight /kg/ 68,6



SM102

length /mm/ 1565
 width /mm/ 930
 height /mm/ 1918
 weight /kg/ 89



SM106

length /mm/ 1033
 width /mm/ 496
 height /mm/ 2051
 weight /kg/ 74,5

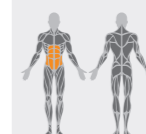

FITNESS MACHINES

SM107
 length /mm/ 1236
 width /mm/ 1145
 height /mm/ 1524
 weight /kg/ 65,2

SM108
 length /mm/ 646
 width /mm/ 845
 height /mm/ 1829
 weight /kg/ 57

SM109
 length /mm/ 1654
 width /mm/ 1175
 height /mm/ 582
 weight /kg/ 73

SM110
 length /mm/ 916
 width /mm/ 800
 height /mm/ 1119
 weight /kg/ 44,7

SM112
 length /mm/ 1567
 width /mm/ 984
 height /mm/ 2413
 weight /kg/ 92,6

SM114
 length /mm/ 1830
 width /mm/ 564
 height /mm/ 1368
 weight /kg/ 88

SM114-4
 length /mm/ 1830
 width /mm/ 1830
 height /mm/ 1368
 weight /kg/ 148,9

SM115
 length /mm/ 489
 width /mm/ 1012
 height /mm/ 1429
 weight /kg/ 59,5

SM116
 length /mm/ 1396
 width /mm/ 566
 height /mm/ 1779
 weight /kg/ 96,7

SM117
 length /mm/ 1125
 width /mm/ 1125
 height /mm/ 2508
 weight /kg/ 70

SM125
 length /mm/ 1340
 width /mm/ 722
 height /mm/ 1570
 weight /kg/ 57,4

SM126
 length /mm/ 1559
 width /mm/ 551
 height /mm/ 1108
 weight /kg/ 78

SM126-136
 length /mm/ 1455
 width /mm/ 548
 height /mm/ 1458
 weight /kg/ 81,6

SM128
 length /mm/ 1541
 width /mm/ 1230
 height /mm/ 2008
 weight /kg/ 119,9

SM129
 length /mm/ 1561
 width /mm/ 1088
 height /mm/ 928
 weight /kg/ 67

SM131
 length /mm/ 1029
 width /mm/ 902
 height /mm/ 1982
 weight /kg/ 72,4

SM134
 length /mm/ 1000
 width /mm/ 653
 height /mm/ 743
 weight /kg/ 32,6

SM135
 length /mm/ 1340
 width /mm/ 722
 height /mm/ 1570
 weight /kg/ 57,4

SM136-142
 length /mm/ 1264
 width /mm/ 792
 height /mm/ 1458
 weight /kg/ 85,1

SM136
 length /mm/ 1352
 width /mm/ 564
 height /mm/ 1458
 weight /kg/ 80,8

SM139
 length /mm/ 1290
 width /mm/ 490
 height /mm/ 699
 weight /kg/ 72

SM144-T
 length /mm/ 1897
 width /mm/ 542
 height /mm/ 1662
 weight /kg/ 101,4

SERIES «SMP»

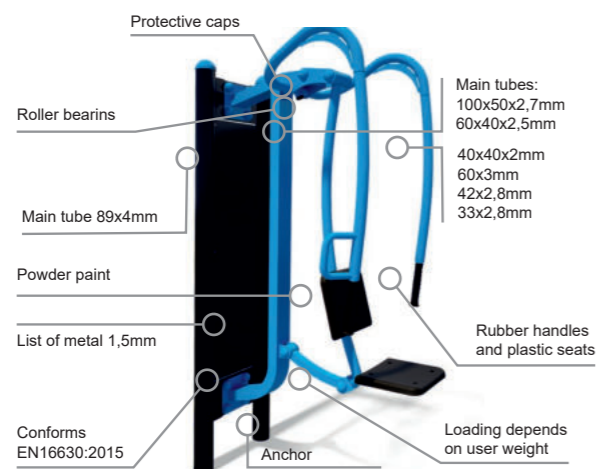

SMP101.1

length /mm/ 875
width /mm/ 1022
height /mm/ 1756
weight /kg/ 47

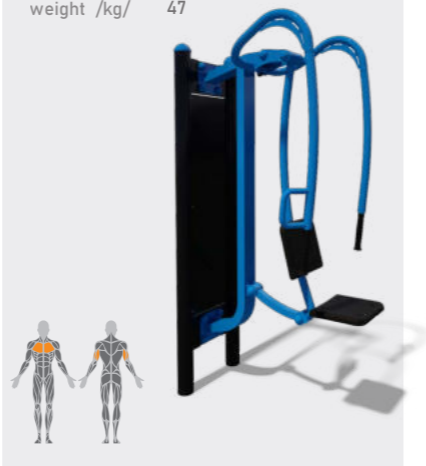

SMP102.1

length /mm/ 935
width /mm/ 1038
height /mm/ 1647
weight /kg/ 40.8



SMP103.1

length /mm/ 1113
width /mm/ 500
height /mm/ 1620
weight /kg/ 31



SMP104.1

length /mm/ 792
width /mm/ 767
height /mm/ 1620
weight /kg/ 30

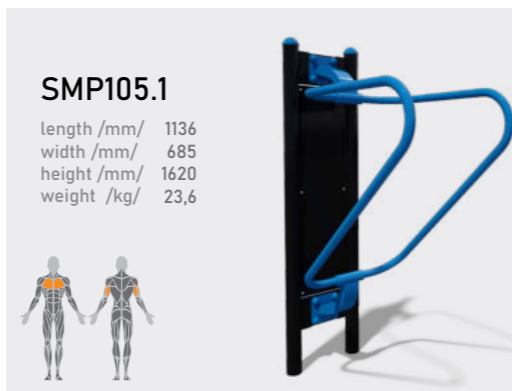

SMP105.1

length /mm/ 1136
width /mm/ 685
height /mm/ 1620
weight /kg/ 23,6



SMP106.1

length /mm/ 757
width /mm/ 496
height /mm/ 1620
weight /kg/ 33.2



SMP107.1

length /mm/ 872
width /mm/ 1145
height /mm/ 1620
weight /kg/ 34.7



SMP108.1

length /mm/ 567
width /mm/ 845
height /mm/ 1620
weight /kg/ 27.2



SMP109.1

length /mm/ 1463
width /mm/ 690
height /mm/ 528
weight /kg/ 35



SMP110.1

length /mm/ 1187
width /mm/ 800
height /mm/ 1115
weight /kg/ 42.9



SMP112.1

length /mm/ 732
width /mm/ 983
height /mm/ 2285
weight /kg/ 29.6

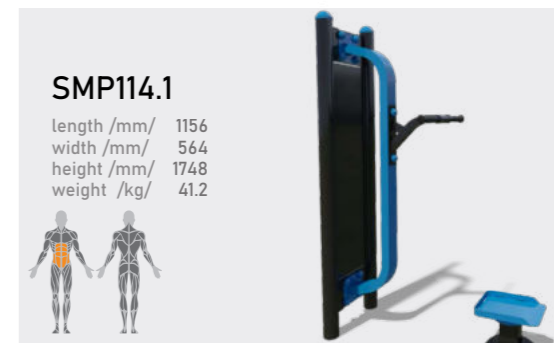

SMP114.1

length /mm/ 1156
width /mm/ 564
height /mm/ 1748
weight /kg/ 41.2



SMP115.1

length /mm/ 1269
width /mm/ 489
height /mm/ 1489
weight /kg/ 57



SMP116.1

length /mm/ 1605
width /mm/ 566
height /mm/ 1844
weight /kg/ 94



SMP125.1

length /mm/ 935
width /mm/ 704
height /mm/ 1620
weight /kg/ 23,3

SMP128.1
 length /mm/ 1027
 width /mm/ 1230
 height /mm/ 2014
 weight /kg/ 60

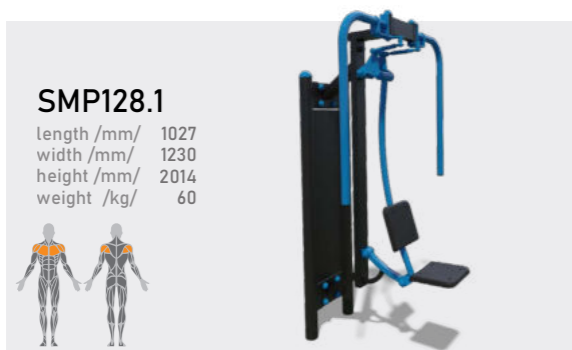

SMP134.1
 length /mm/ 1129
 width /mm/ 653
 height /mm/ 803
 weight /kg/ 30



SMP135.1
 length /mm/ 987
 width /mm/ 957
 height /mm/ 962
 weight /kg/ 45



SMP139.1
 length /mm/ 1536
 width /mm/ 490
 height /mm/ 699
 weight /kg/ 67,7



SMP136.1
 length /mm/ 916
 width /mm/ 564
 height /mm/ 1620
 weight /kg/ 39,7



SMP142.1
 length /mm/ 824
 width /mm/ 792
 height /mm/ 1620
 weight /kg/ 43,8

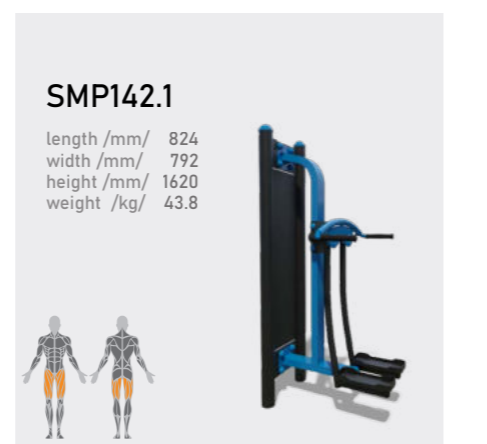

SMP141.1
 length /mm/ 1409
 width /mm/ 602
 height /mm/ 1580
 weight /kg/ 62,5



MACHINES CAN BE CONNECTED FROM BOTH SIDES OF PYLON

USE PYLON AS ADVERTISEMENT PLACE

YOU CAN COMBINE ALL MACHINES



SERIES «SE/SL»

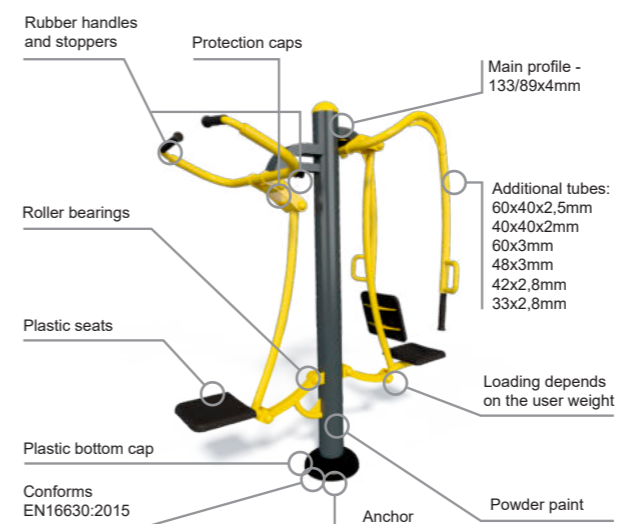

SE103
 length /mm/ 1777
 width /mm/ 500
 height /mm/ 1548
 weight /kg/ 68,5



SE104
 length /mm/ 1088
 width /mm/ 797
 height /mm/ 1426
 weight /kg/ 61



SE101
 length /mm/ 1596
 width /mm/ 875
 height /mm/ 1948
 weight /kg/ 107



SE104-114
 length /mm/ 1332
 width /mm/ 797
 height /mm/ 1426
 weight /kg/ 76



SE101-102
 length /mm/ 1584
 width /mm/ 875
 height /mm/ 1948
 weight /kg/ 97



SE107
 length /mm/ 1233
 width /mm/ 1145
 height /mm/ 1524
 weight /kg/ 70,6

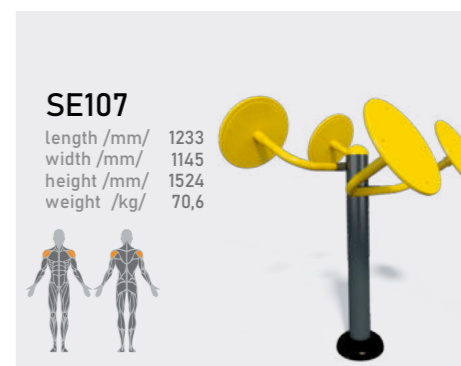

SE102
 length /mm/ 1578
 width /mm/ 874
 height /mm/ 1848
 weight /kg/ 86



SE108
 length /mm/ 680
 width /mm/ 845
 height /mm/ 1827
 weight /kg/ 61



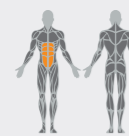

SE109
 length /mm/ 1280
 width /mm/ 1274
 height /mm/ 553
 weight /kg/ 58

SE110
 length /mm/ 928
 width /mm/ 725
 height /mm/ 1109
 weight /kg/ 45





SE129
 length /mm/ 1593
 width /mm/ 1088
 height /mm/ 998
 weight /kg/ 68

SE131
 length /mm/ 1027
 width /mm/ 902
 height /mm/ 1981
 weight /kg/ 76

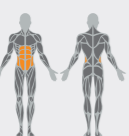

SE114
 length /mm/ 1283
 width /mm/ 1472
 height /mm/ 1353
 weight /kg/ 112

SE115-T
 length /mm/ 1071
 width /mm/ 481
 height /mm/ 1518
 weight /kg/ 71





SE135
 length /mm/ 1123
 width /mm/ 824
 height /mm/ 887
 weight /kg/ 49



SE116
 length /mm/ 1186
 width /mm/ 625
 height /mm/ 1658
 weight /kg/ 69



SE123.1
 length /mm/ 1685
 width /mm/ 1567
 height /mm/ 1948
 weight /kg/ 120



SE136
 length /mm/ 1213
 width /mm/ 553
 height /mm/ 1435
 weight /kg/ 80



SE103-142
 length /mm/ 1477
 width /mm/ 792
 height /mm/ 1548
 weight /kg/ 80,8





SE126
 length /mm/ 1510
 width /mm/ 544
 height /mm/ 1076
 weight /kg/ 73



SE139
 length /mm/ 979
 width /mm/ 482
 height /mm/ 1382
 weight /kg/ 49



SE140
 length /mm/ 1083
 width /mm/ 815
 height /mm/ 1564
 weight /kg/ 72

SE126-136
 length /mm/ 1360
 width /mm/ 641
 height /mm/ 1435
 weight /kg/ 79





SE128
 length /mm/ 1547
 width /mm/ 1230
 height /mm/ 2051
 weight /kg/ 129





SE141-T
 length /mm/ 918
 width /mm/ 602
 height /mm/ 1517
 weight /kg/ 66



SE142
 length /mm/ 1177
 width /mm/ 793
 height /mm/ 1358
 weight /kg/ 83

SE143
 length /mm/ 1514
 width /mm/ 763
 height /mm/ 1548
 weight /kg/ 110

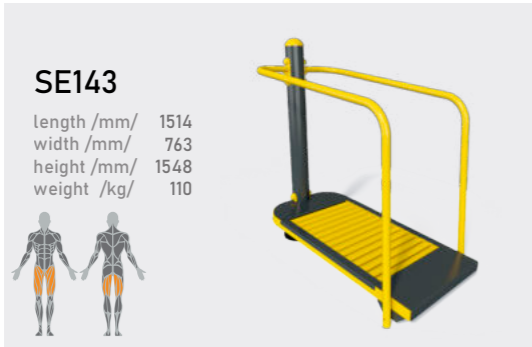

SE201
 length /mm/ 952
 width /mm/ 875
 height /mm/ 1948
 weight /kg/ 72,6



SE202
 length /mm/ 942
 width /mm/ 935
 height /mm/ 1948
 weight /kg/ 66,1

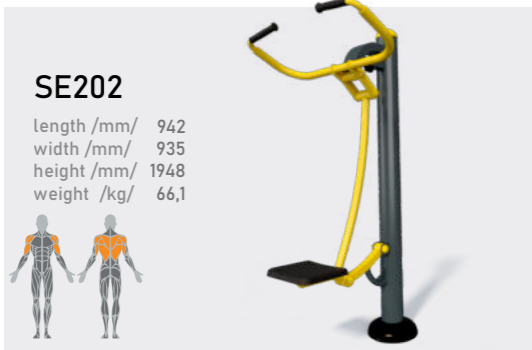

SE203
 length /mm/ 1039
 width /mm/ 500
 height /mm/ 1548
 weight /kg/ 52



SE204
 length /mm/ 694
 width /mm/ 797
 height /mm/ 1426
 weight /kg/ 47

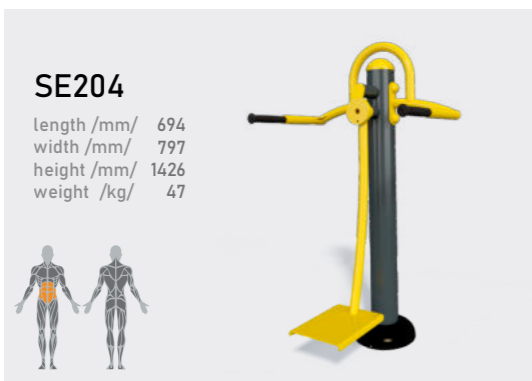

SE226
 length /mm/ 903
 width /mm/ 540
 height /mm/ 1076
 weight /kg/ 47



SE228
 length /mm/ 927
 width /mm/ 1230
 height /mm/ 2051
 weight /kg/ 85,1



SE242
 length /mm/ 738
 width /mm/ 792
 height /mm/ 1358
 weight /kg/ 56,9



SE236
 length /mm/ 843
 width /mm/ 545
 height /mm/ 1435
 weight /kg/ 55,9



SE117-125-126
 length /mm/ 1540
 width /mm/ 1440
 height /mm/ 2570



SL105
 length /mm/ 1740
 width /mm/ 580
 height /mm/ 1550
 weight /kg/ 52



SL106
 length /mm/ 1300
 width /mm/ 440
 height /mm/ 1070
 weight /kg/ 44



SL106.1
 length /mm/ 1000
 width /mm/ 480
 height /mm/ 2010
 weight /kg/ 55



SL117
 length /mm/ 1170
 width /mm/ 1170
 height /mm/ 2550
 weight /kg/ 75

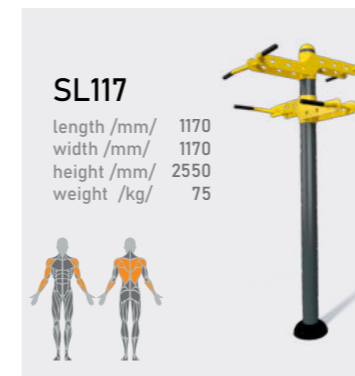

SL118
 length /mm/ 680
 width /mm/ 630
 height /mm/ 2650
 weight /kg/ 65

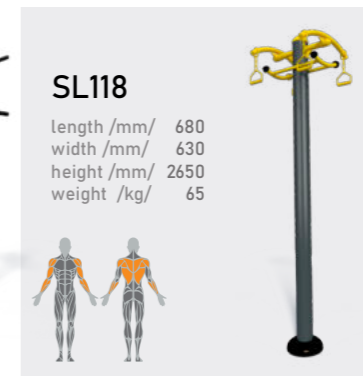

SL121
 length /mm/ 1000
 width /mm/ 1000
 height /mm/ 1280
 weight /kg/ 46

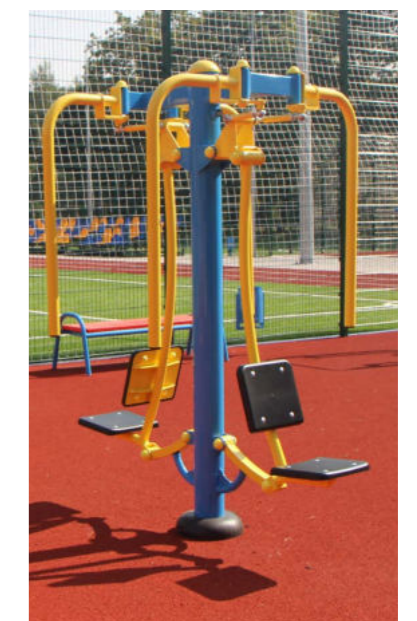
SL125
 length /mm/ 1330
 width /mm/ 720
 height /mm/ 1540
 weight /kg/ 61

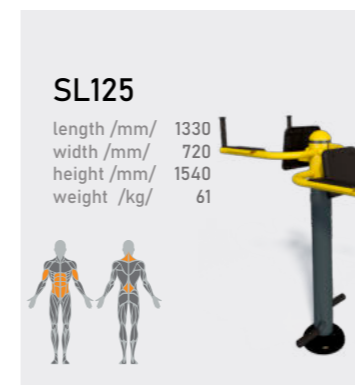

SL134
 length /mm/ 1010
 width /mm/ 690
 height /mm/ 740
 weight /kg/ 39

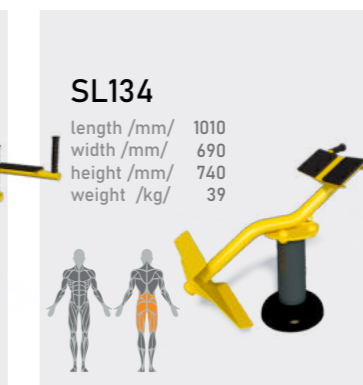

SL301
 length /mm/ 1567
 width /mm/ 899
 height /mm/ 1428
 weight /kg/ 54



OUTDOOR SPORT COMPLEXES FOR ARMY OR MILITARY USE

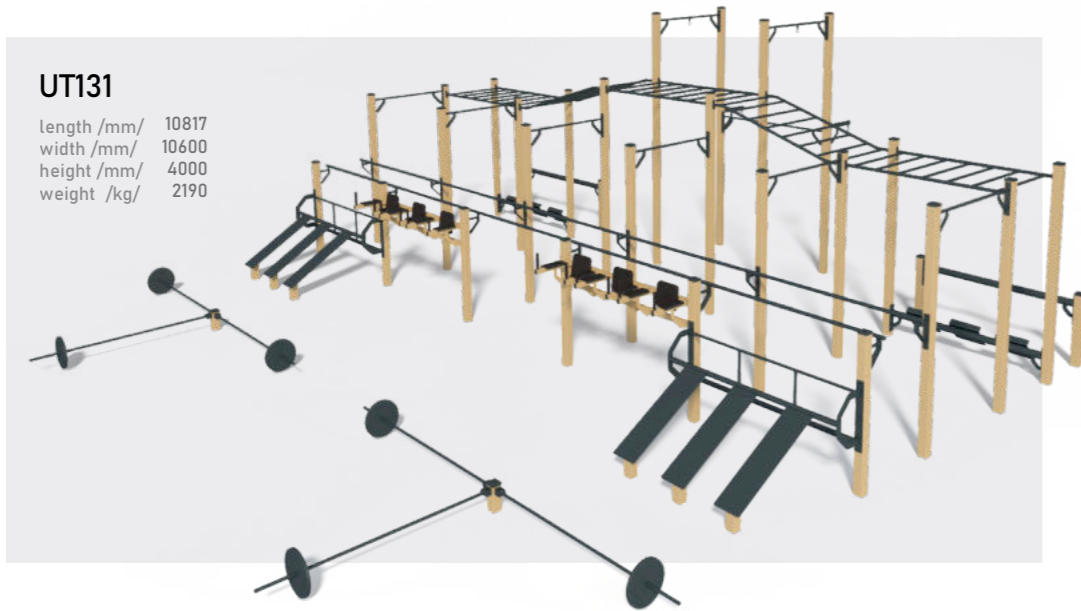

UT131
 length /mm/ 10817
 width /mm/ 10600
 height /mm/ 4000
 weight /kg/ 2190

WEIGHT RESISTANCE MACHINES

SERIES «KF»

You can change the resistance of training on these machines using the movable weight-stack.

You can make complete workout session with the progress in the weights, as you are used in professional gym.



Bench press

KF801

length /mm/ 2384
 width /mm/ 1450
 height /mm/ 1218
 weight /kg/ 200



Shoulder press

KF802

length /mm/ 1596
 width /mm/ 1628
 height /mm/ 1498
 weight /kg/ 235



Leg press

KF803

length /mm/ 2846
 width /mm/ 938
 height /mm/ 1571
 weight /kg/ 283



Rowing machine

KF804

length /mm/ 1710
 width /mm/ 1225
 height /mm/ 1103
 weight /kg/ 185



Upper pull

KF805

length /mm/ 2238
 width /mm/ 1445
 height /mm/ 1907
 weight /kg/ 217



RECOMMENDATIONS

FOR USE OF PROFESSIONAL KF EQUIPMENT

It is recommended to install these machines only on the playgrounds with limited access.

It is prohibited to allow children on these playgrounds.

Every playground has to have information stickers with information regarding safety, emergency and maintaining services.

Deadlift

KF806

length /mm/ 2389
 width /mm/ 1718
 height /mm/ 1195
 weight /kg/ 321

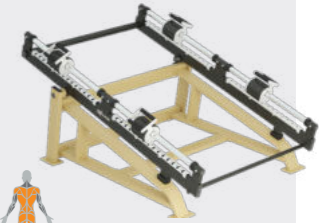

Squat machine

KF807

length /mm/ 1463
 width /mm/ 1508
 height /mm/ 1405
 weight /kg/ 196



Butterfly

KF808

length /mm/ 2196
 width /mm/ 2140
 height /mm/ 644
 weight /kg/ 218

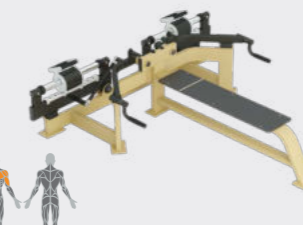

Delta machine

KF809

length /mm/ 849
 width /mm/ 2130
 height /mm/ 1496
 weight /kg/ 220



Biceps machine

KF810

length /mm/ 1187
 width /mm/ 1233
 height /mm/ 1055
 weight /kg/ 137



Triceps

KF811

length /mm/ 2573
 width /mm/ 999
 height /mm/ 1138
 weight /kg/ 228

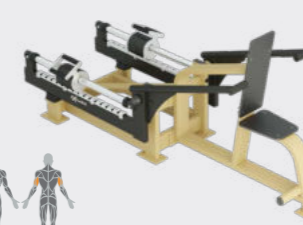

Hip extension

KF812

length /mm/ 1437
 width /mm/ 1619
 height /mm/ 1359
 weight /kg/ 246



Combines pull-up

KF814

length /mm/ 1589
 width /mm/ 1094
 height /mm/ 2485
 weight /kg/ 129



Scott bench

KF815

length /mm/ 2230
 width /mm/ 2366
 height /mm/ 1055
 weight /kg/ 196

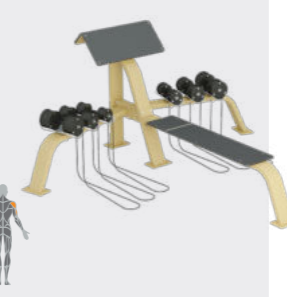

Scott bench

KF815.1

length /mm/ 749
 width /mm/ 2366
 height /mm/ 1055
 weight /kg/ 175

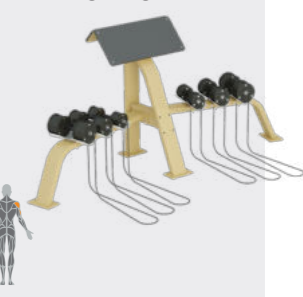

FITNESS MACHINES



PARK FURNITURE

KIDS BENCHES

S721.1

length /mm/ 1620
width /mm/ 670
height /mm/ 880

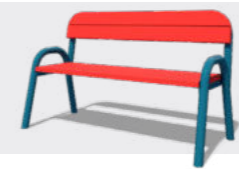

S722.1

length /mm/ 1620
width /mm/ 670
height /mm/ 560



S741

length /mm/ 1200
width /mm/ 360
height /mm/ 450



S744

length /mm/ 1250
width /mm/ 716
height /mm/ 820

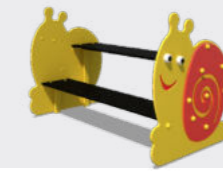

S745

length /mm/ 1250
width /mm/ 635
height /mm/ 690



S746

length /mm/ 1250
width /mm/ 850
height /mm/ 568



S747

length /mm/ 1230
width /mm/ 556
height /mm/ 538



FENCES

S764.4

length /mm/ 900
width /mm/ 100
height /mm/ 1000

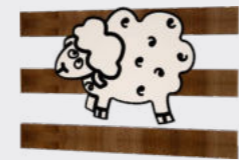

S764.9

length /mm/ 900
width /mm/ 100
height /mm/ 1000



S764.11

length /mm/ 900
width /mm/ 100
height /mm/ 1000



S764.5

length /mm/ 900
width /mm/ 100
height /mm/ 1000



S764.12

length /mm/ 900
width /mm/ 100
height /mm/ 1000



S764.15

length /mm/ 900
width /mm/ 100
height /mm/ 1000



S764.6

length /mm/ 900
width /mm/ 100
height /mm/ 1000



S739

length /mm/ 1500
width /mm/ 20
height /mm/ 744

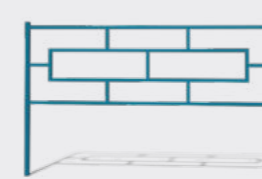

S739.1

length /mm/ 1500
width /mm/ 20
height /mm/ 852



S707.1

length /mm/ 1535
width /mm/ 42
height /mm/ 953

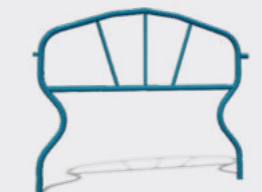

S743

length /mm/ 1460
width /mm/ 400
height /mm/ 880



05

COMPLECTS OF PARK FURNITURE

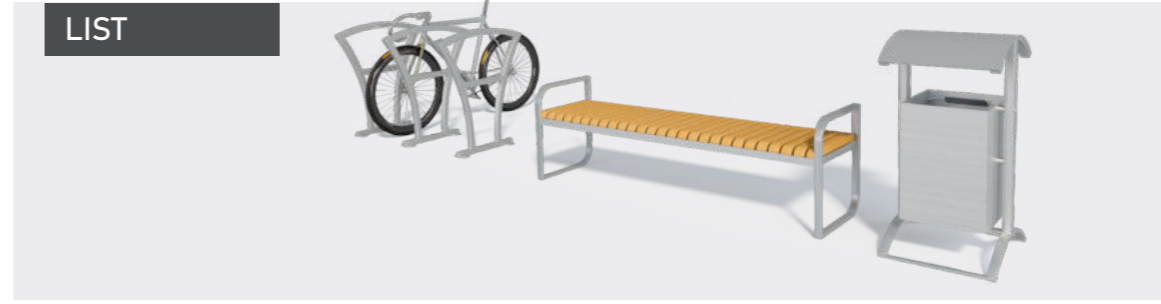
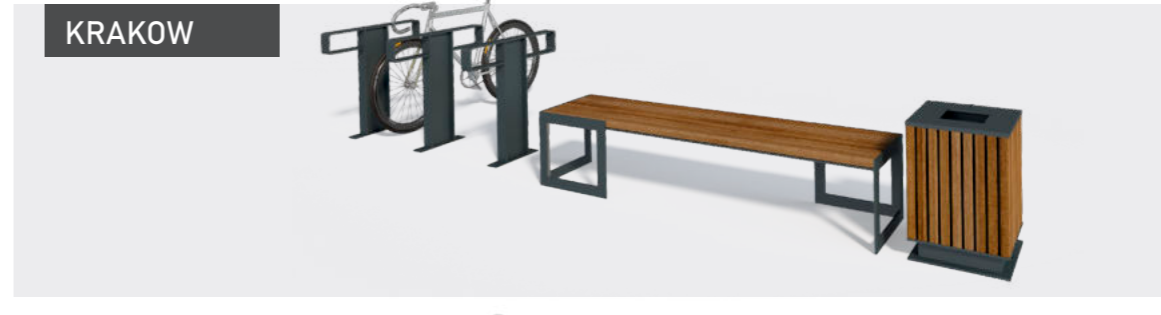
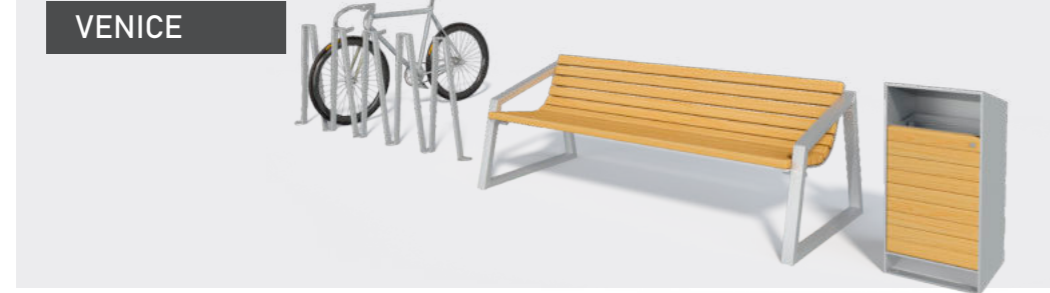
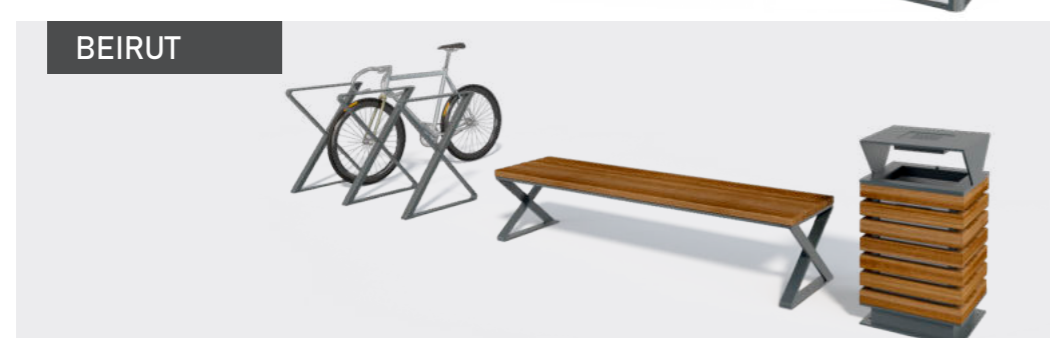
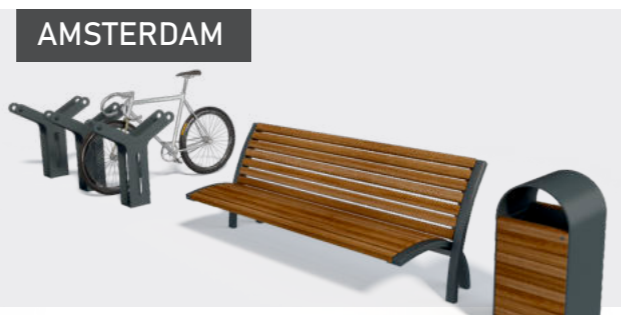

PARK FURNITURE

TRIANGLE



TRIBUNE



PARIS



PRAGUE



TRASH BINS

LP201 length /mm/ 480
width /mm/ 450
height /mm/ 720
місткість /л/ 45



LP202

length /mm/ 575
width /mm/ 402
height /mm/ 720
місткість /л/ 45



LP204

length /mm/ 520
width /mm/ 430
height /mm/ 1030
weight /kg/ 62,8



LP205

length /mm/ 350
width /mm/ 300
height /mm/ 615
місткість /л/ 30



Clumbe LP008.2

length /mm/ 721
width /mm/ 627
height /mm/ 684
weight /kg/ 63,7



LP207/LP208

length /mm/ 193
width /mm/ 182
height /mm/ 1074
weight /kg/ 5,8/13,6



BICYCLE PARKING

LP501

length /mm/ 1650
width /mm/ 820
height /mm/ 820



LP302

length /mm/ 240
width /mm/ 161
height /mm/ 1000



LP301

length /mm/ 260
width /mm/ 80
height /mm/ 1000



PARK BENCHES

LP002

length /mm/ 1710
width /mm/ 566
height /mm/ 845



LP003

length /mm/ 1680
width /mm/ 560
height /mm/ 769



LP006

length /mm/ 1710
width /mm/ 503
height /mm/ 793



LP002.1

length /mm/ 1710
width /mm/ 421
height /mm/ 400



LP003.1

length /mm/ 1680
width /mm/ 473
height /mm/ 435



LP006.1

length /mm/ 1710
width /mm/ 410
height /mm/ 406



LP012

length /mm/ 1172
width /mm/ 495
height /mm/ 400

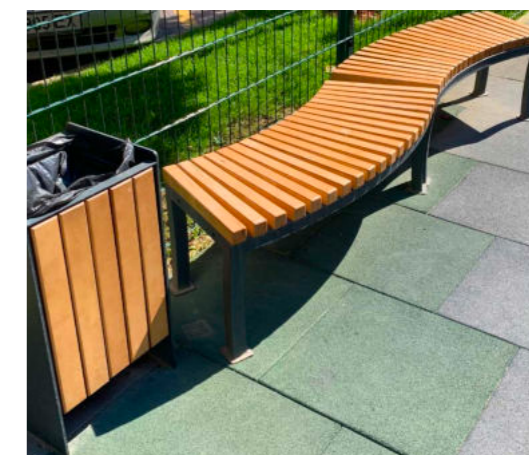

LP013

length /mm/ 1830
width /mm/ 640
height /mm/ 781



LP004.1

length /mm/ 1680
width /mm/ 410
height /mm/ 410

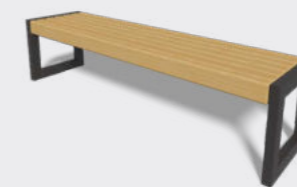

LPS004 *Стіл*

length /mm/ 1680
width /mm/ 735
height /mm/ 735



PARK FURNITURE

LP014
length /mm/ 1200
width /mm/ 410
height /mm/ 401



LP014.1
length /mm/ 1202
width /mm/ 410
height /mm/ 401



LP014.2
length /mm/ 1631
width /mm/ 410
height /mm/ 398



LP015
length /mm/ 1520
width /mm/ 475
height /mm/ 400



LP013.1
length /mm/ 1830
width /mm/ 624
height /mm/ 400



LP016
length /mm/ 1805
width /mm/ 450
height /mm/ 600

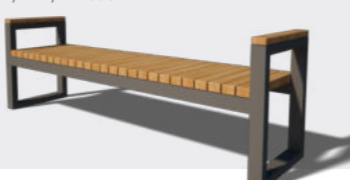

LP017
length /mm/ 1815
width /mm/ 450
height /mm/ 400



LP018
length /mm/ 1800
width /mm/ 575
height /mm/ 775



LP019
length /mm/ 1800
width /mm/ 448
height /mm/ 475



LP008.1
length /mm/ 1669
width /mm/ 401
height /mm/ 400



LP031
length /mm/ 1800
width /mm/ 458
height /mm/ 433

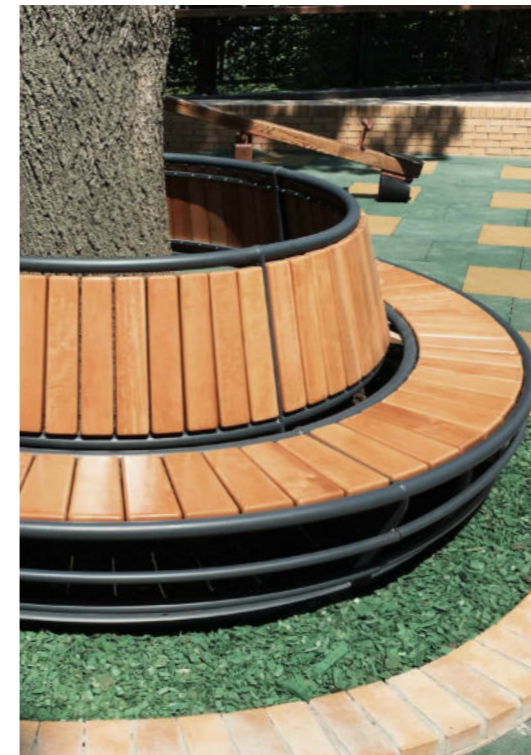

LP032
length /mm/ 1836
width /mm/ 926
height /mm/ 1239

LP033
length /mm/ 1802
width /mm/ 400
height /mm/ 400



LP034
length /mm/ 3000
width /mm/ 3000
height /mm/ 860



LP035-1.7
length /mm/ 1750
width /mm/ 693
height /mm/ 763



LP035.1-1.7
length /mm/ 1750
width /mm/ 693
height /mm/ 514



LP083
length /mm/ 1805
width /mm/ 551
height /mm/ 686



LP061
length /mm/ 1760
width /mm/ 588
height /mm/ 807



LP062
length /mm/ 1620
width /mm/ 538
height /mm/ 689



LP063
length /mm/ 1760
width /mm/ 587
height /mm/ 728



LP064
length /mm/ 1710
width /mm/ 524
height /mm/ 714



LP065
length /mm/ 1598
width /mm/ 702
height /mm/ 850





DOG TRAINING EQUIPMENT

Barrier
B0002

length /mm/	3000
width /mm/	100
height /mm/	2000
weight /kg/	141,9

Angled wall
B0004

length /mm/	4169
width /mm/	1000
height /mm/	1603
weight /kg/	143

Ring barrier
B0003

length /mm/	1204
width /mm/	761
height /mm/	1477
weight /kg/	22

Direct bridge
B0005

length /mm/	8612
width /mm/	264
height /mm/	997
weight /kg/	120



Slide with ladder
B0006

length /mm/	7016
width /mm/	1000
height /mm/	4047
weight /kg/	366

Slalom
B0011

length /mm/	7000
width /mm/	850
height /mm/	1000
weight /kg/	48.7

Hang
B0014

length /mm/	93
width /mm/	93
height /mm/	150
weight /kg/	0,77

Information booth
B0016

length /mm/	400
width /mm/	250
height /mm/	2296
weight /kg/	29

Barrier
B0017

length /mm/	1058
width /mm/	400
height /mm/	1000
weight /kg/	9



PLAY SPORTS EQUIPMENT

UT401

length /mm/ 230
width /mm/ 100
height /mm/ 3020
weight /kg/ 50



UT402

length /mm/ 170
width /mm/ 100
height /mm/ 1640
weight /kg/ 27



UT405

length /mm/ 910
width /mm/ 1200
height /mm/ 900
weight /kg/ 31



UT406.1-01

length /mm/ 2022
width /mm/ 1200
height /mm/ 3890
weight /kg/ 81.3



UT409

length /mm/ 1800
width /mm/ 900
height /mm/ 1052
weight /kg/ 44



UT600

length /mm/ 3170
width /mm/ 980
height /mm/ 2480
weight /kg/ 81



UT601

length /mm/ 1926
width /mm/ 686
height /mm/ 1268
weight /kg/ 29



UT410

length /mm/ 2070
width /mm/ 1800
height /mm/ 3930
weight /kg/ 128



UT720-22

length /mm/ 6666
width /mm/ 1370
height /mm/ 1565
weight /kg/ 366



UT208.6

length /mm/ 3080
width /mm/ 770
height /mm/ 2036
weight /kg/ 132.6



UT720-15

length /mm/ 14992
width /mm/ 1370
height /mm/ 1565
weight /kg/ 837

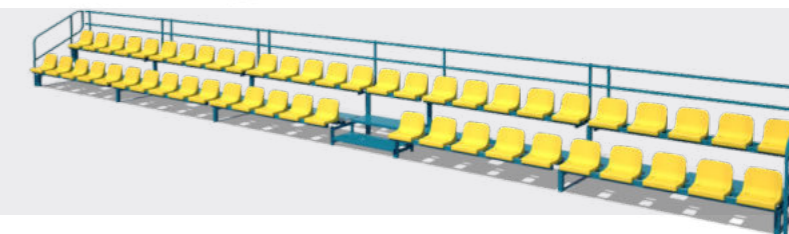

UT712

length /mm/ 2636
width /mm/ 524
height /mm/ 353
weight /kg/ 34



UT705

length /mm/ 6668
width /mm/ 3105
height /mm/ 2365
weight /kg/ 1030

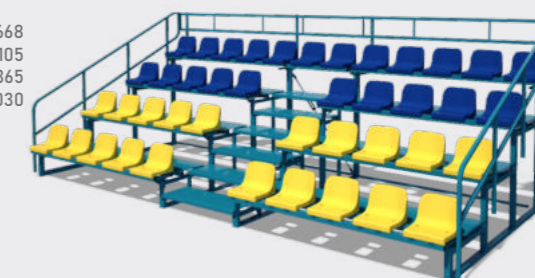

SAFETY SURFACE FOR CHILDRENS AND SPORTS PLAYGROUNDS

SAFETY SURFACE IS ONE OF THE MOST IMPORTANT PARTS OF THE PLAYGROUNDS.

VISUAL EFFECT

it gives nice look to children and sports zone, and it provides design to the playground and it's surroundings.

QUALITY OF THE SURFACE

It serves to prevent injuries for the users during play and exercising activities, it extends the durability of the equipment and the playground itself, helps to keep it clean, safe and soft.



MODULAR PLASTIC TILES

This surface is made from pure polyethylene under high pressure with the addition of color pigments. This surface has high durability, UV resistant, high electrosafety, heat saving and etc.

You can use it on the playgrounds, near garages, warehouses, pools, territories of rest and fun activities.



POLYURETHANE SURFACE



Polyurethane surface is made from recycled rubber, EPDM rubber granules and polyurethane glues.

This play and safety surface has following characteristics:

- Wide colour range
- UV resistant
- High durability
- No joints
- Big term of usage
- Stable against natural wear
- Wateribility
- Low injury risk
- Easy to maintain



ARTIFICIAL GRASS

Artificial grass gives an opportunity to reduce costs and efficiency comparative to natural grass surface. Artificial grass has high quality characteristics and big term of usage.

It is used for professional sports, children playgrounds and landscape zones.

You can use it for all kinds of play sports: football, tennis, basketball, rugby, golf, volleyball, grass-hockey.



POLYURETHANE FIGURES

You can use polyurethane figures of manual production on the all kinds of playground for design, visual look and play activities.

They are made from EPDM rubber granules with the addition of polyurethane glue. They are compact, have straight surface, have good by touch sensations.

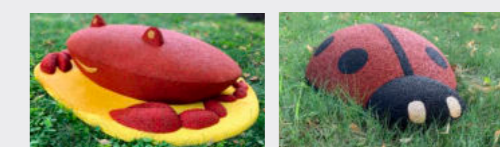

PROJECTS FOR PLAYGROUNDS

We can make projects of any children or sports playgrounds with calculation of safety requirements and the place of the object.

When we combine the equipment, we aim to make it safe, fun, action and entertainment for the users.



NOTES

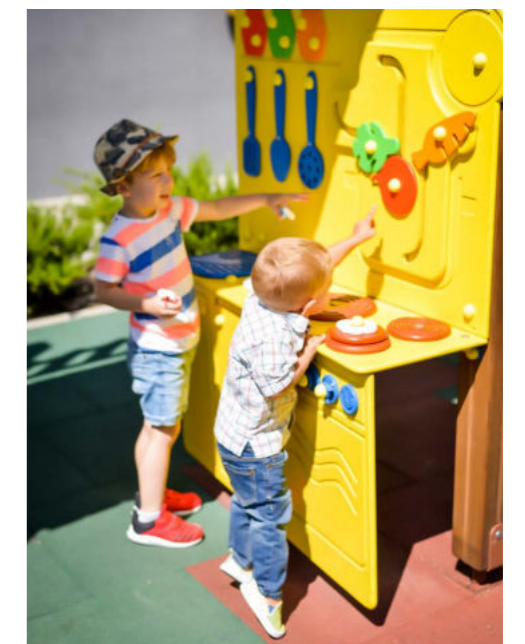
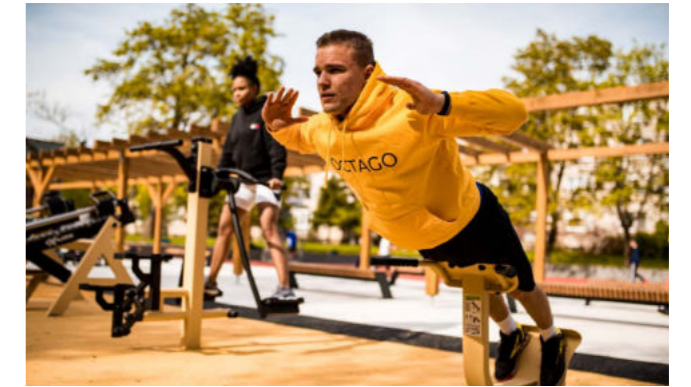

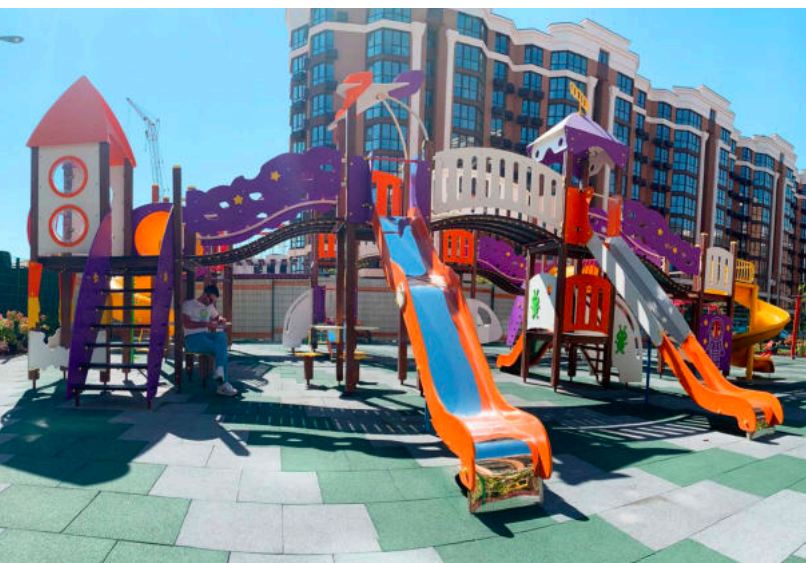

INTER ATLETIKA GROUP OF COMPANIES



08293, Ukraine, Bucha, Institutska
17B



+38 (044) 333-70-16



kids@interatletika.com



@play.interatletika



@play.interatletika



play.interatletika.ua

